

➤ General Description

This PAP3023ANS P-Channel enhancement mode power field effect transistor is the high density trench technology and this advanced technology can provide excellent $R_{ds(On)}$ performance and efficiency for power switching and load switching application., this device also comply with the RoHS and Green Product requirement with full function reliability approved.

➤ Feature

- Super high density cell design for extremely low $R_{DS(ON)}$
- Exceptional on-resistance and maximum DC current capability
- SOT-23S package design

➤ SOT-23S

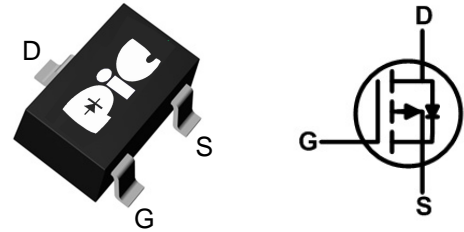

➤ Application

- Battery Switch for Portable Devices
- Computers
 - Bus Switch
 - Load Switch LED Display

➤ Absolute Maximum Ratings

Parameter	Symbol	Rating	Unit
Drain-Source Voltage	V_{DSS}	-30	V
Gate –Source Voltage	V_{GSS}	± 20	V
Continuous Drain Current($T_J=150^\circ C$)	I_D	$T_A=25^\circ C$	-3.6
		$T_A=70^\circ C$	-2.4
Pulsed Drain Current	I_{DM}	-15	A
Continuous Source Current(Diode Conduction)	I_S	-1.5	A
Power Dissipation	P_D	$T_A=25^\circ C$	1.25
		$T_A=70^\circ C$	0.8
Operating Junction Temperature	T_J	150	$^\circ C$
Storage Temperature Range	T_{STG}	-55/150	$^\circ C$
Thermal Resistance-Junction to Ambient	$R_{\theta JA}$	120	$^\circ C/W$

➤ **Electrical Characteristics ($T_A=25^\circ C$ Unless otherwise noted)**

Parameter	Symbol	Conditions	Min.	Typ	Max.	Unit
Static						
Drain-Source Breakdown Voltage	$V_{(BR)DSS}$	$V_{GS}=0V, I_D=-250\mu A$	-30			V
Gate Threshold Voltage	$V_{GS(th)}$	$V_{DS}=V_{GS}, I_D=-250\mu A$	-1.0		-2.6	V
Gate Leakage Current	I_{GSS}	$V_{DS}=0V, V_{GS}=\pm 20V$			± 100	nA
Zero Gate Voltage Drain Current	I_{DSS}	$V_{DS}=-24V, V_{GS}=0V$			-1	uA
		$V_{DS}=-24V, V_{GS}=0V$ $T_A=85^\circ C$			-30	
On-State Drain Current	$I_{D(on)}$	$V_{DS} \leq -5V, V_{GS}=-10V$	-10			A
Drain-Source On-Resistance	$R_{DS(on)}$	$V_{GS}=-10.0V, I_D=-2.8A$		140	155	m Ω
		$V_{GS}=-4.5V, I_D=-2.4A$		220	240	
Forward Transconductance	g_{FS}	$V_{DS}=-5V, I_D=-4.0A$		10		S
Diode Forward Voltage	V_{SD}	$I_S=-1.5A, V_{GS}=0V$		-0.7	-1.3	V
Dynamic						
Total Gate Charge	Q_g	$V_{DS}=-15V, V_{GS}=-4.5V$ $I_D=-2.5A$		2.5		nC
Gate-Source Charge	Q_{gs}			0.8		
Gate-Drain Charge	Q_{gd}			1.0		
Input Capacitance	C_{iss}	$V_{DS}=-15V, V_{GS}=0V$ $f=1MHz$		170		pF
Output Capacitance	C_{oss}			50		
Reverse Transfer Capacitance	C_{rss}			30		
Turn-On Time	$t_{d(on)}$	$V_{DD}=-15V, R_L=7.5\Omega$ $I_D=-2.0A, V_{GEN}=-10V$ $R_G=1\Omega$		5	10	ns
	t_r			10	16	
Turn-Off Time	$t_{d(off)}$			10	16	
	t_f			5	10	

➤ Typical Characteristics

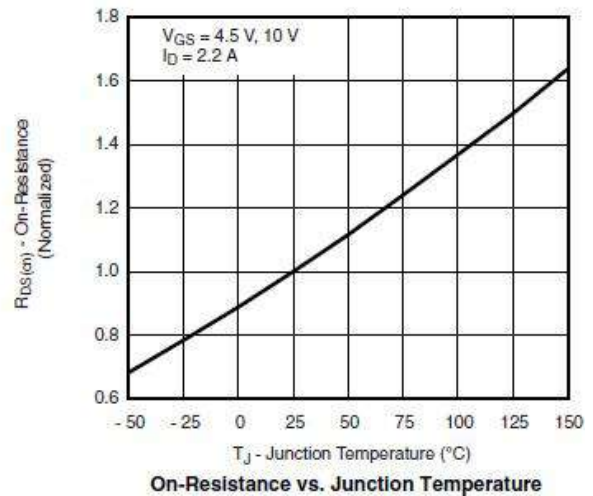
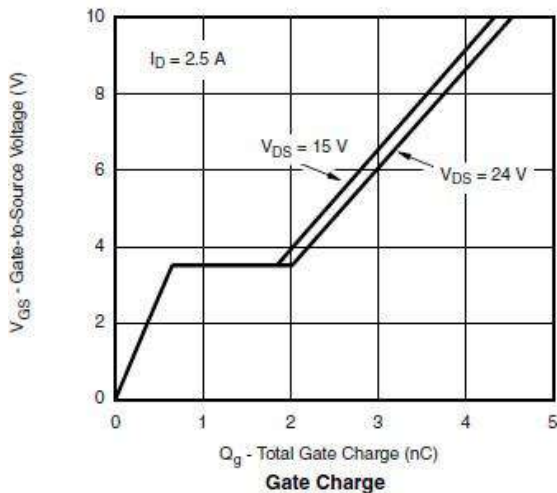
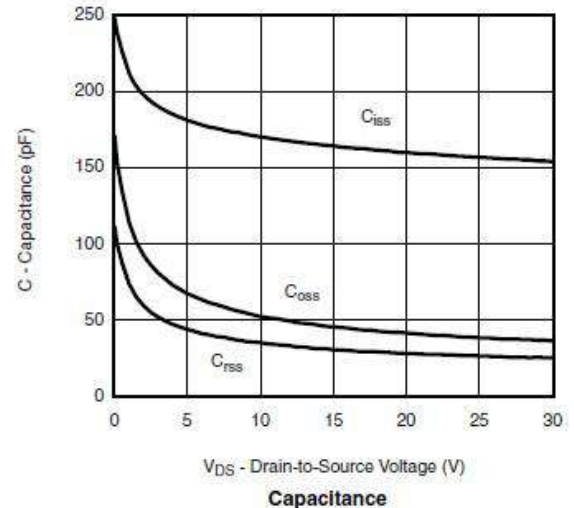
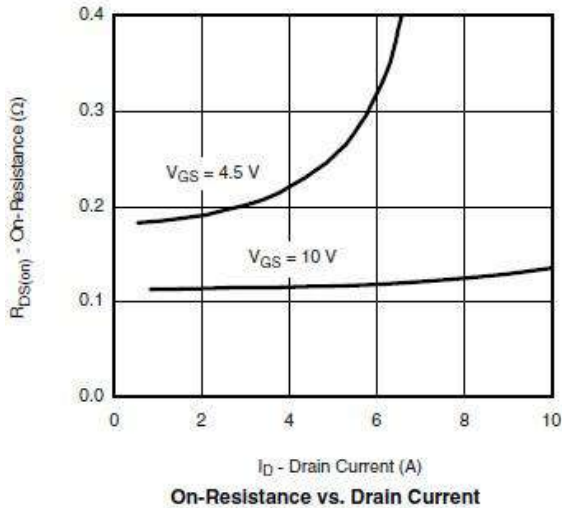
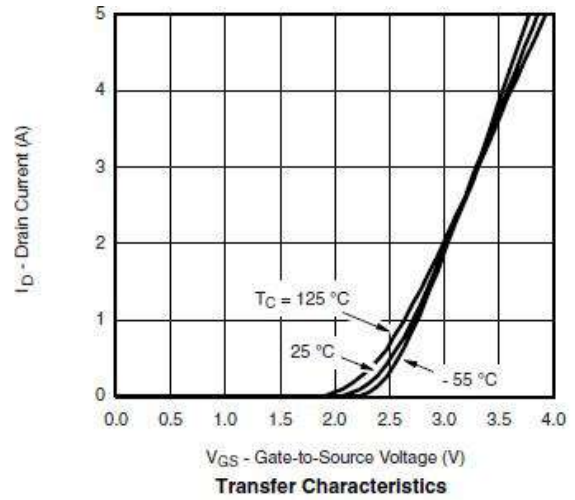
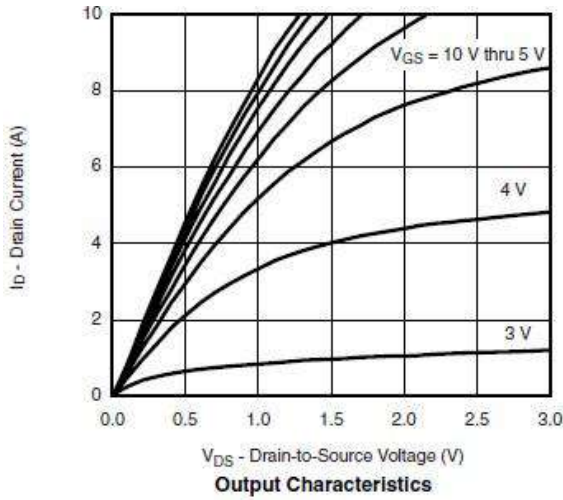

P-Ch -30V Fast Switching MOSFET
 $V_{DS}=-30V$, $I_D=-3.6A$, $R_{DS(ON)}=155m\Omega$

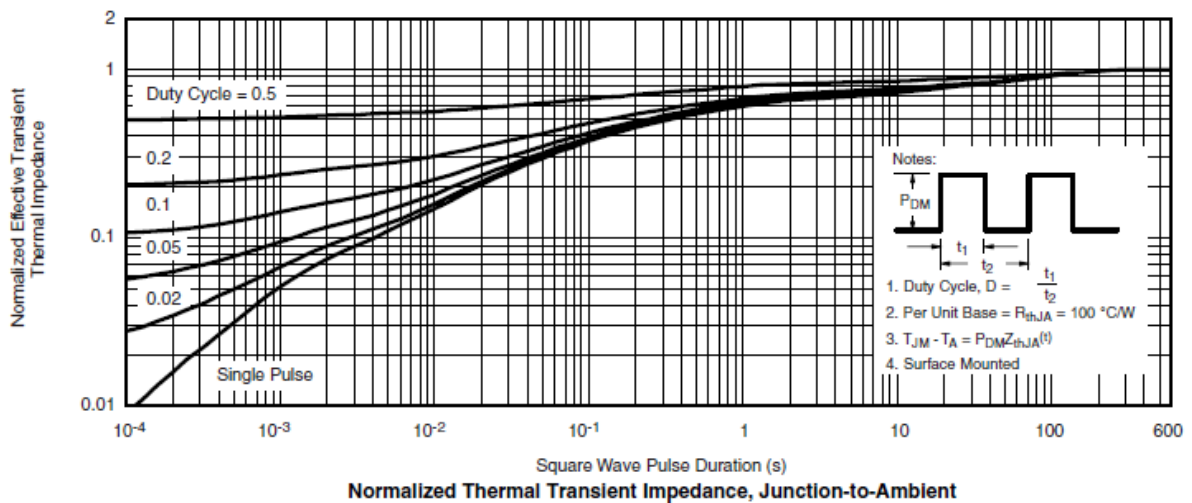
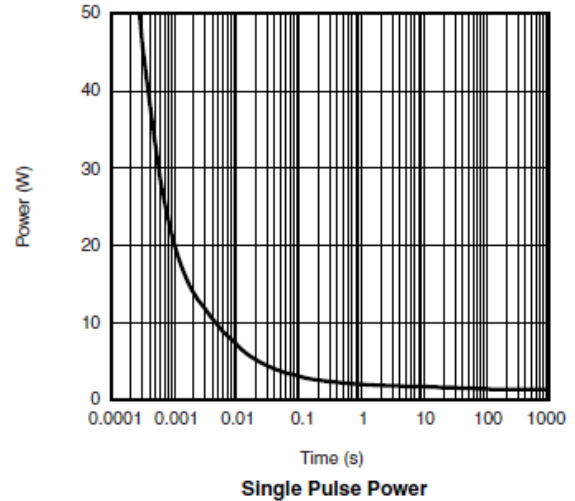
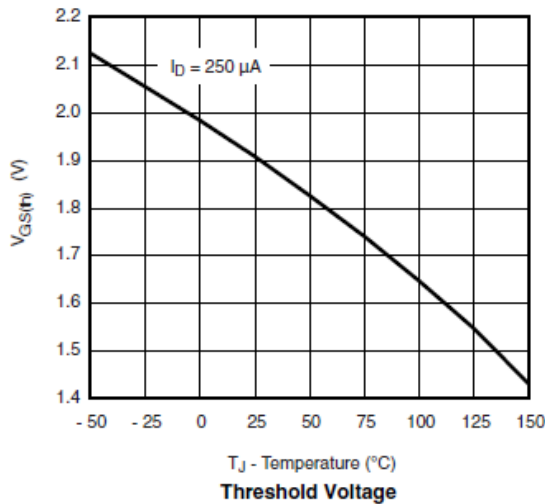
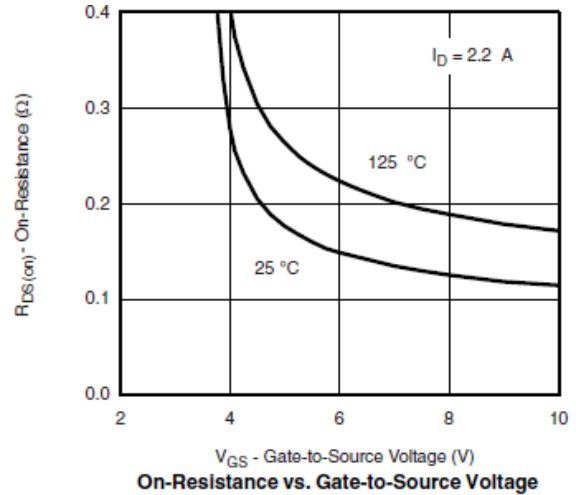
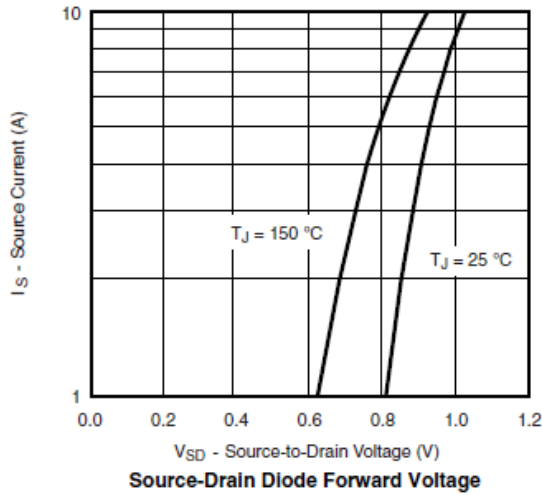

➤ Recommand IR Reflow Soldering Thermal Profile



Profile Feature	Pb-Free Assembly Profile
Temperature Min. (T _{smin})	150°C
Temperature Max. (T _{smax})	200°C
Time (t _s) from (T _{smin} to T _{smax})	60-120 seconds
Average Ramp-up Rate (t _L to t _P)	3°C/second max.
Liquidous Temperature (T _L)	217°C
Time (t _L) Maintained Above (T _L)	60 – 150 seconds
Peak Temperature	260°C +0°C / -5°C
Time (t _P) within 5°C of actual Peak Temperature	30 seconds
Ramp-down Rate (T _P to T _L)	6°C/second max
Time 25°C to Peak Temperature	8 minutes max.

➤ Ordering Information

Part Number	Description	Quantity
PAP3023ANS	SOT-23S Reel	3000 pcs

➤ Package Information (SOT-23S)

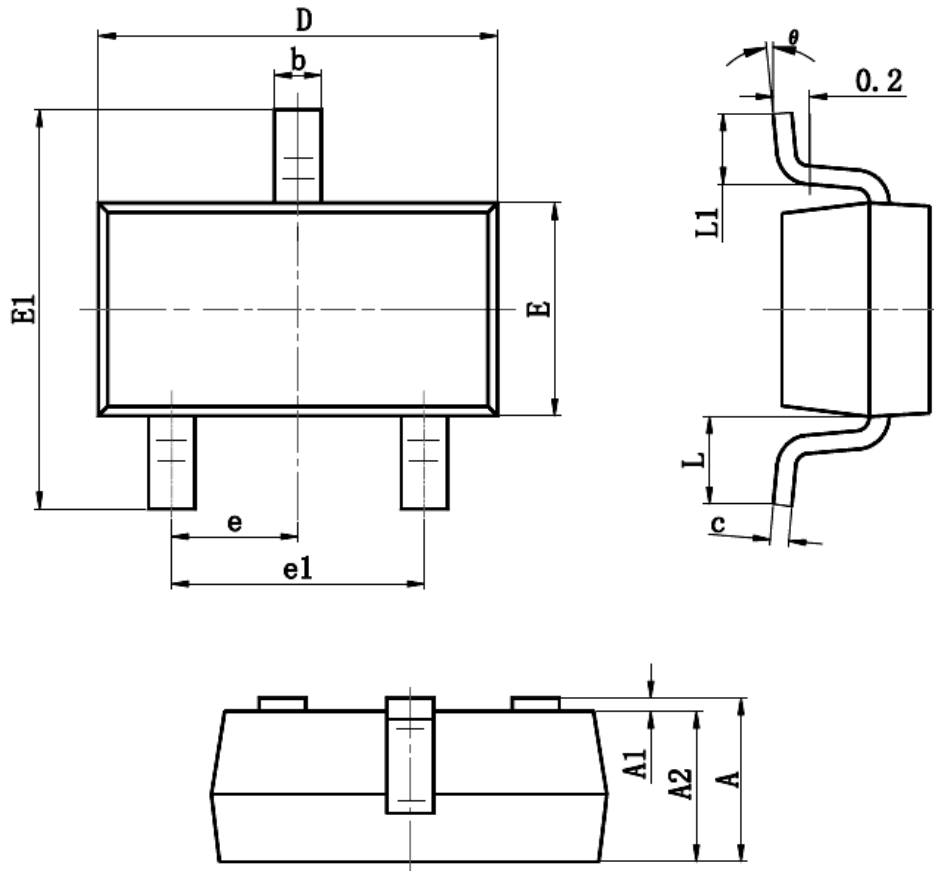

Symbol	Dimensions In Millimeters		Dimensions In Inches	
	Min	Max	Min	Max
A	0.900	1.200	0.035	0.043
A1	0.000	0.100	0.000	0.004
A2	0.900	1.100	0.035	0.039
b	0.300	0.500	0.012	0.020
c	0.080	0.150	0.003	0.006
D	2.800	3.000	0.110	0.118
E	1.200	1.400	0.047	0.055
E1	2.250	2.550	0.089	0.100
e	0.950 TYP		0.037 TYP	
e1	1.800	2.000	0.071	0.079
L	0.550 REF		0.022 REF	
L1	0.300	0.500	0.012	0.020
θ	0°	8°	0°	6°

DISCLAIMER

- The information in this document and any product described herein are subject to change without notice and should not be construed as a commitment by Paceleader, Paceleader reserve the right to make changes to the information in this document.
- Though Paceleader make effort to improve product quality and reliability, Product can malfunction and fail due to their inherent electrical sensitivity and vulnerability to physical stress, it is the responsibility of the customer, when utilizing Paceleader products, to comply with the standards of safety in making a safe design for entire system and to avoid situation in which a malfunction or failure., In developing a new designs, customer should ensure that the device which shown in this documents are used within specified operatingranges.
- The information contained herein is presented only as a guide for the applications of our products. No responsibility is assumed by Paceleader for any infringements of patents or other rights of the third parties which may result from its use.