

## ➤ General Description

This PAN6028ANS N-Channel enhancement mode power field effect transistor is the high density trench technology and this advanced technology can provide excellent  $R_{ds(On)}$  performance and efficiency for power switching and load switching application., this device also comply with the RoHS and Green Product requirement with full function reliability approved.

## ➤ Feature

- Super high density cell design for extremely low  $R_{DS(ON)}$
- Exceptional on-resistance and maximum DC current capability
- SOT-23S package design

## ➤ SOT-23S

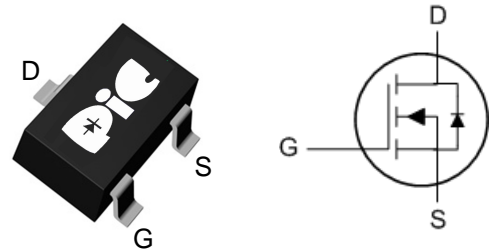

## ➤ Application

- Portable Equipment
- Battery Powered System
- Net Working System

## ➤ Absolute Maximum Ratings

Parameter	Symbol	Rating	Unit
Drain-Source Voltage	$V_{DSS}$	60	V
Gate –Source Voltage	$V_{GSS}$	$\pm 20$	V
Continuous Drain Current( $T_J=150^\circ C$ )	$I_D$	$T_A=25^\circ C$	4.0
		$T_A=70^\circ C$	3.2
Pulsed Drain Current	$I_{DM}$	16	A
Continuous Source Current(Diode Conduction)	$I_S$	1.2	A
Power Dissipation	$P_D$	$T_A=25^\circ C$	1.25
		$T_A=70^\circ C$	0.8
Operating Junction Temperature	$T_J$	150	$^\circ C$
Storage Temperature Range	$T_{STG}$	-55/150	$^\circ C$
Thermal Resistance-Junction to Ambient	$R_{\theta JA}$	120	$^\circ C/W$

➤ **Electrical Characteristics ( $T_A=25^\circ C$  Unless otherwise noted)**

Parameter	Symbol	Conditions	Min.	Typ	Max.	Unit
<b>Static</b>						
Drain-Source Breakdown Voltage	$V_{(BR)DSS}$	$V_{GS}=0V, I_D=250\mu A$	60			V
Gate Threshold Voltage	$V_{GS(th)}$	$V_{DS}=V_{GS}, I_D=250\mu A$	1.0		2.5	
Gate Leakage Current	$I_{GSS}$	$V_{DS}=0V, V_{GS}=\pm 20V$			$\pm 100$	nA
Zero Gate Voltage Drain Current	$I_{DSS}$	$V_{DS}=48V, V_{GS}=0V$			1	uA
		$V_{DS}=48V, V_{GS}=0V$ $T_J=85^\circ C$			10	
On-State Drain Current	$I_{D(on)}$	$V_{DS} \geq 5V, V_{GS}=10V$	4.0			A
Drain-Source On-Resistance	$R_{DS(on)}$	$V_{GS}=10V, I_D=4.0A$		40	48	m $\Omega$
		$V_{GS}=4.5V, I_D=3.2A$		45	54	
Forward Transconductance	$g_{FS}$	$V_{DS}=15V, I_D=4.0A$		10		S
Diode Forward Voltage	$V_{SD}$	$I_S=2A, V_{GS}=0V$		0.8	1.3	V
<b>Dynamic</b>						
Total Gate Charge	$Q_g$	$V_{DS}=30V, V_{GS}=4.5V$ $I_D=4.0A$		6	10	nC
Gate-Source Charge	$Q_{gs}$			2.4		
Gate-Drain Charge	$Q_{gd}$			2.6		
Input Capacitance	$C_{iss}$	$V_{DS}=15V, V_{GS}=0V$ $f=1MHz$		885		pF
Output Capacitance	$C_{oss}$			85		
Reverse Transfer Capacitance	$C_{rss}$			45		
Turn-On Time	$t_{d(on)}$	$V_{DD}=30V, R_L=7\Omega$ $I_D=4.0A, V_{GEN}=10V$ $R_G=1.0\Omega$		10	20	ns
	$t_r$			15	30	
Turn-Off Time	$t_{d(off)}$			20	40	
	$t_f$			10	20	

## ➤ Typical Characteristics

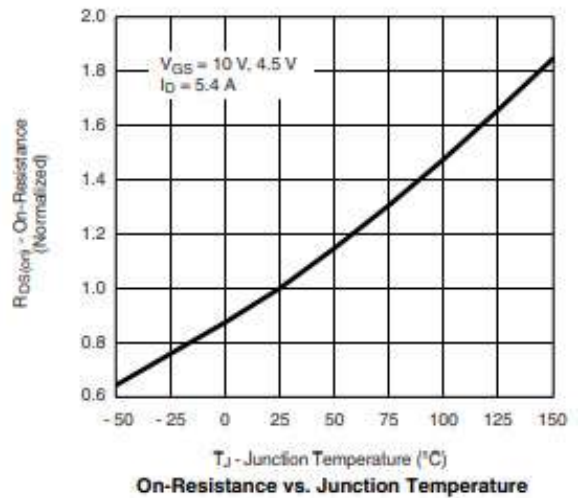
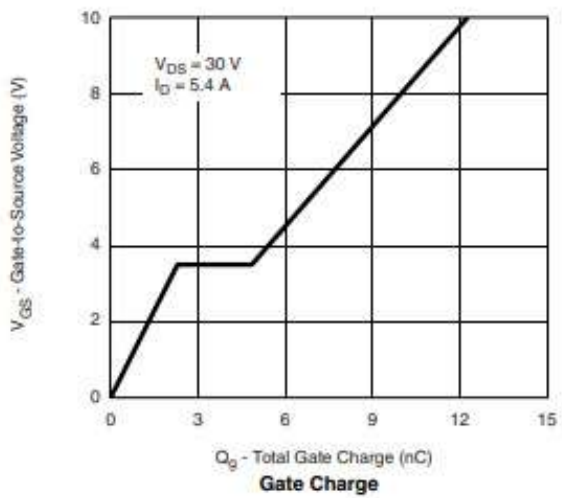
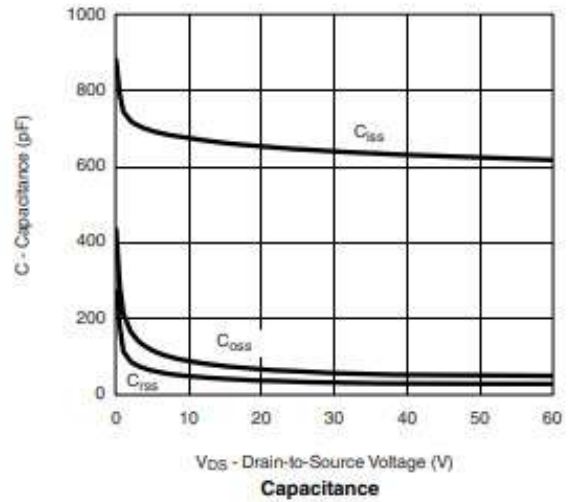
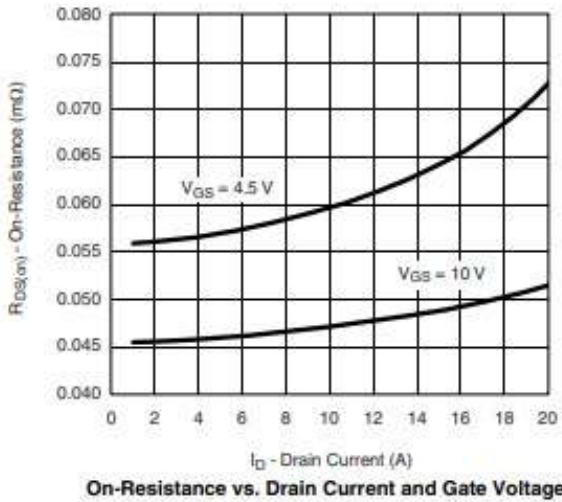
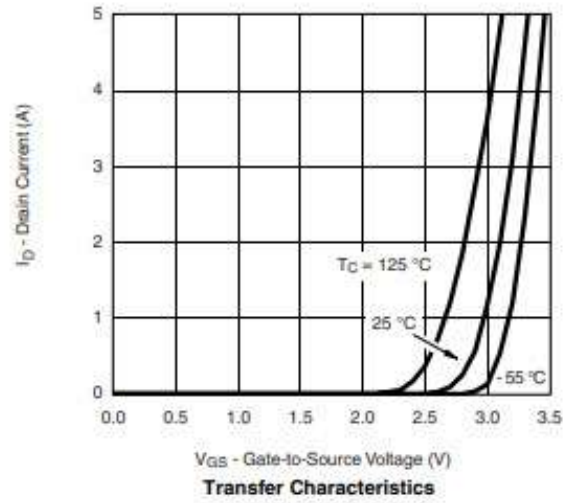
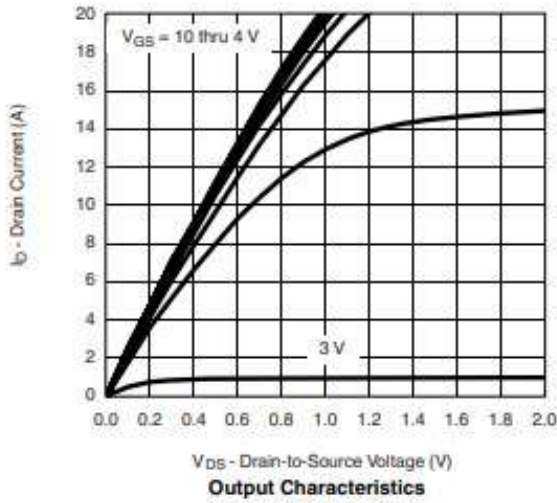

N-Ch 60V Fast Switching MOSFET  
 $V_{DS}=60V$ ,  $I_D=4.0A$ ,  $R_{DS(on)}=48m\Omega$

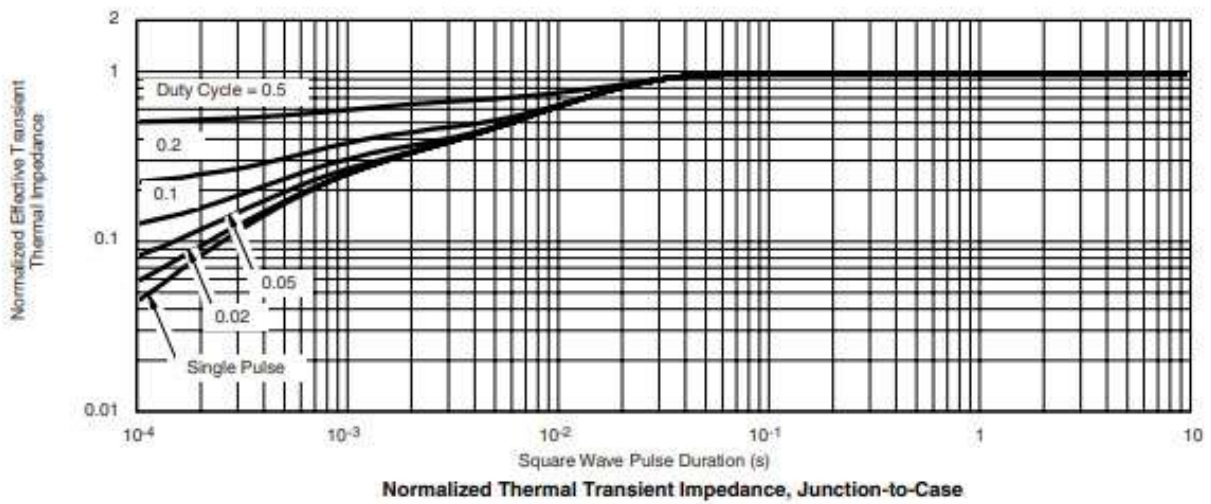
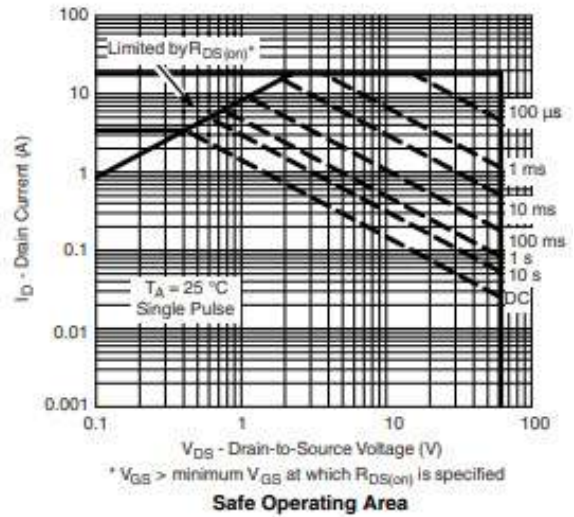
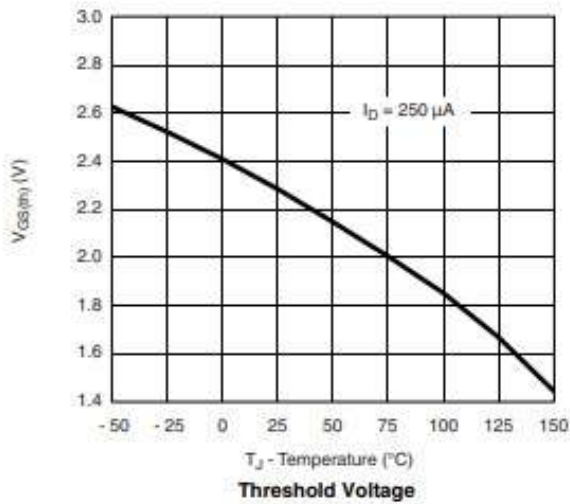
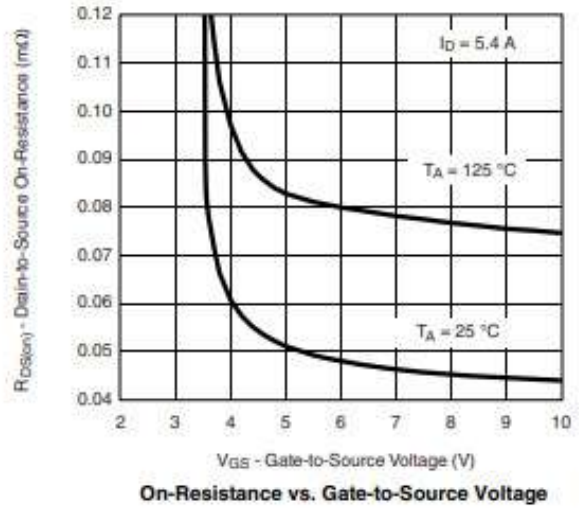
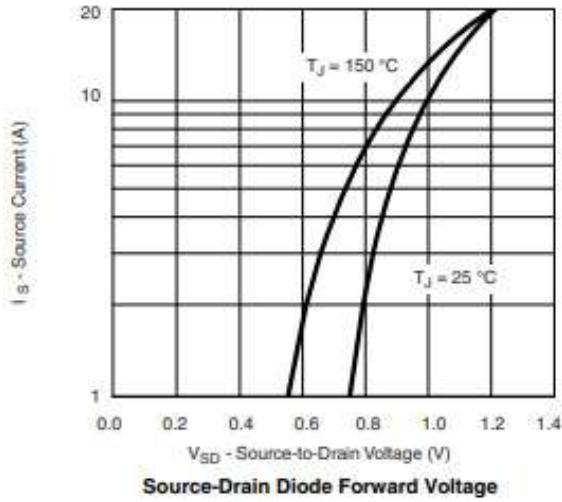

➤ Recommand IR Reflow Soldering Thermal Profile

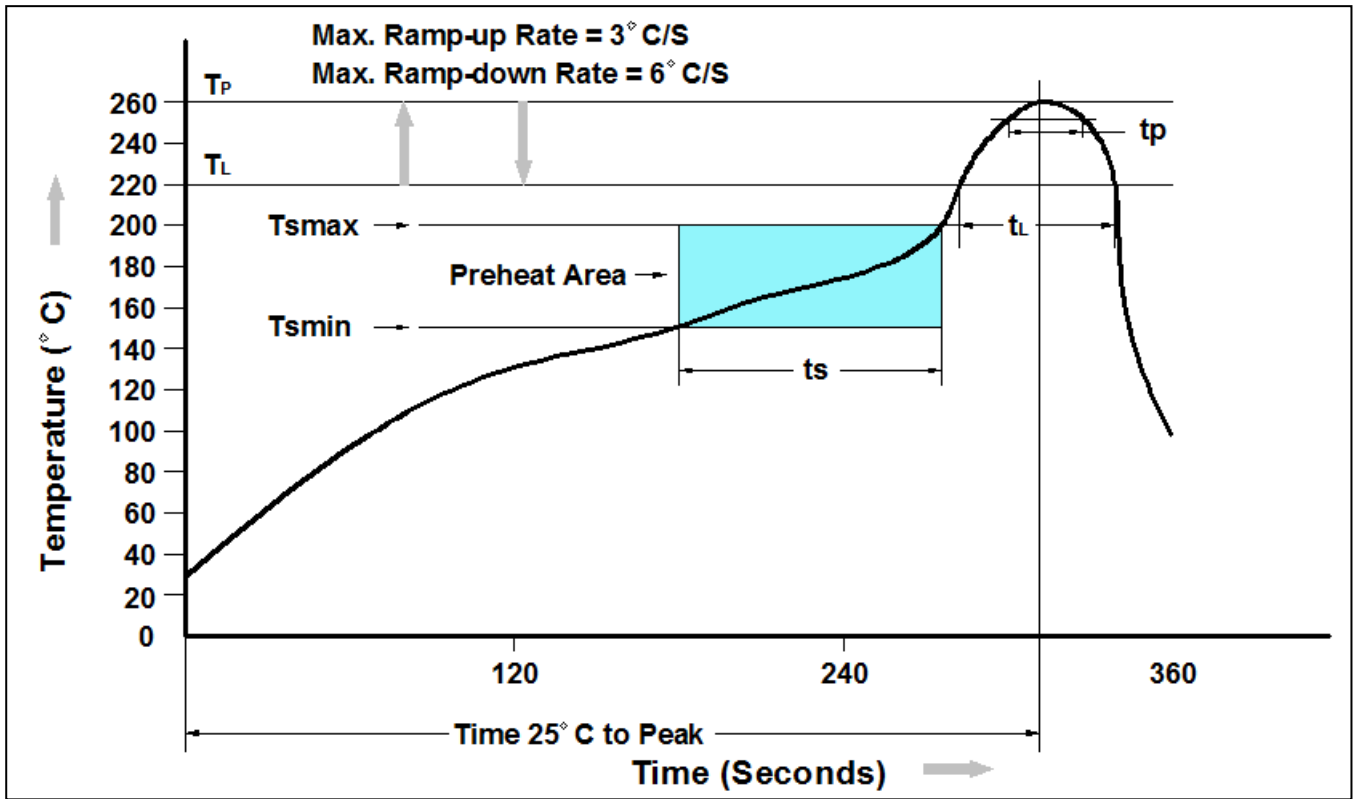

Profile Feature	Pb-Free Assembly Profile
Temperature Min. (T <sub>smin</sub> )	150°C
Temperature Max. (T <sub>smax</sub> )	200°C
Time (t <sub>s</sub> ) from (T <sub>smin</sub> to T <sub>smax</sub> )	60-120 seconds
Average Ramp-up Rate (t <sub>L</sub> to t <sub>P</sub> )	3°C/second max.
Liquidous Temperature (T <sub>L</sub> )	217°C
Time (t <sub>L</sub> ) Maintained Above (T <sub>L</sub> )	60 – 150 seconds
Peak Temperature	260°C +0°C / -5°C
Time (t <sub>P</sub> ) within 5°C of actual Peak Temperature	30 seconds
Ramp-down Rate (T <sub>P</sub> to T <sub>L</sub> )	6°C/second max
Time 25°C to Peak Temperature	8 minutes max.

➤ Ordering Information

Part Number	Description	Quantity
PAN6028ANS	SOT-23S Reel	3000 pcs

➤ Package Information ( SOT-23S )

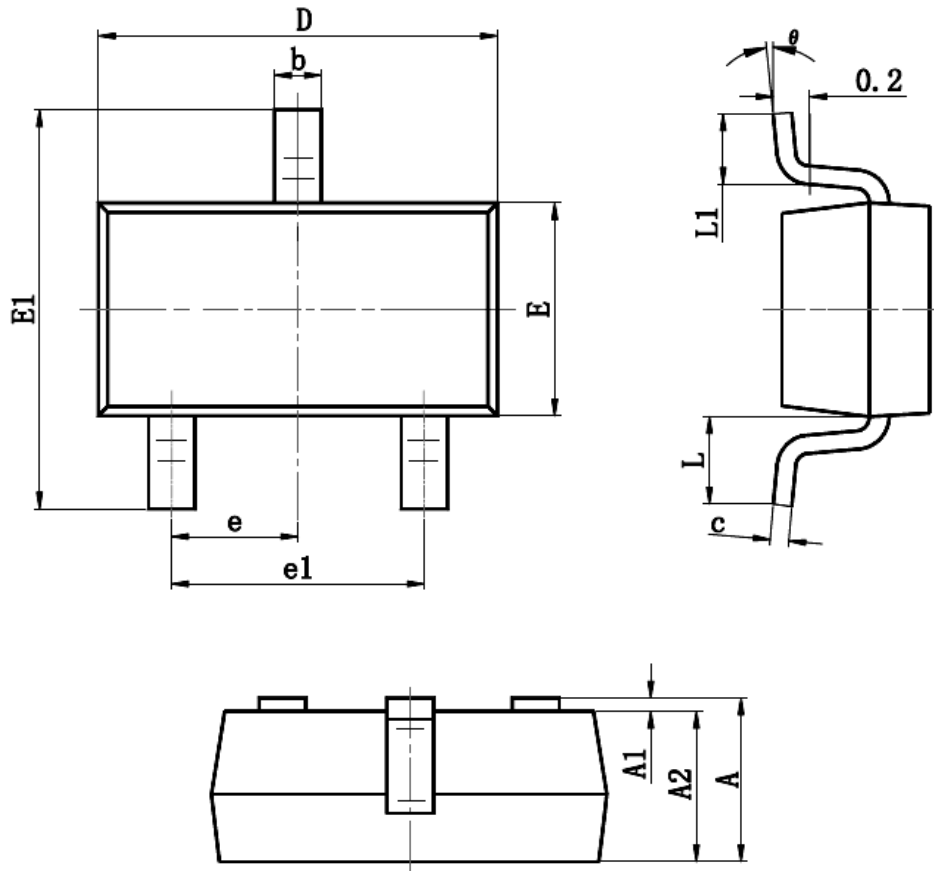

Symbol	Dimensions In Millimeters		Dimensions In Inches	
	Min	Max	Min	Max
A	0.900	1.200	0.035	0.043
A1	0.000	0.100	0.000	0.004
A2	0.900	1.100	0.035	0.039
b	0.300	0.500	0.012	0.020
c	0.080	0.150	0.003	0.006
D	2.800	3.000	0.110	0.118
E	1.200	1.400	0.047	0.055
E1	2.250	2.550	0.089	0.100
e	0.950 TYP		0.037 TYP	
e1	1.800	2.000	0.071	0.079
L	0.550 REF		0.022 REF	
L1	0.300	0.500	0.012	0.020
θ	0°	8°	0°	6°

## DISCLAIMER

- The information in this document and any product described herein are subject to change without notice and should not be construed as a commitment by Paceleader, Paceleader reserve the right to make changes to the information in this document.
- Though Paceleader make effort to improve product quality and reliability, Product can malfunction and fail due to their inherent electrical sensitivity and vulnerability to physical stress, it is the responsibility of the customer, when utilizing Paceleader products, to comply with the standards of safety in making a safe design for entire system and to avoid situation in which a malfunction or failure., In developing a new designs, customer should ensure that the device which shown in this documents are used within specified operatingranges.
- The information contained herein is presented only as a guide for the applications of our products. No responsibility is assumed by Paceleader for any infringements of patents or other rights of the third parties which may result from its use.