

### ➤ General Description

This PAN30TV14V N-Channel enhancement mode power field effect transistor is the high density trench technology and this advanced technology can provide excellent  $R_{ds(On)}$  performance and efficiency for power switching and load switching application., this device also comply with the RoHS and Green Product requirement with full function reliability approved.

### ➤ Feature

- Super Low Gate Charge
- 100% EAS Guaranteed
- Green Device Available
- Excellent  $CdV/dt$  effect decline
- Advanced high cell density Trench technology

### ➤ DFN3X3A-EP1

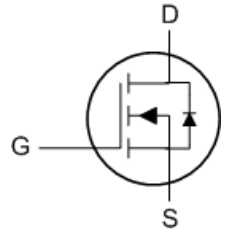
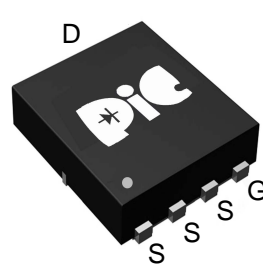

### ➤ Application

- DC/DC Primary Side Switch
- Industrial Synchronous
- Rectification Load Switch
- DC/DC Converters

### ➤ Absolute Maximum Ratings

Parameter	Symbol	Rating	Units
Drain-Source Voltage	$V_{DS}$	30	V
Gate-Source Voltage	$V_{GS}$	$\pm 20$	V
Continuous Drain Current, $V_{GS} @ 10V^1$	$I_D@T_C=25^\circ C$	37	A
Continuous Drain Current, $V_{GS} @ 10V^1$	$I_D@T_C=100^\circ C$	24	A
Continuous Drain Current, $V_{GS} @ 10V^1$	$I_D@T_A=25^\circ C$	9.5	A
Continuous Drain Current, $V_{GS} @ 10V^1$	$I_D@T_A=70^\circ C$	7.6	A
Pulsed Drain Current <sup>2</sup>	$I_{DM}$	75	A
Single Pulse Avalanche Energy <sup>3</sup>	EAS	24.2	mJ
Avalanche Current	$I_{AS}$	22	A
Total Power Dissipation <sup>4</sup>	$P_D@T_C=25^\circ C$	26	W
Total Power Dissipation <sup>4</sup>	$P_D@T_A=25^\circ C$	1.67	W
Storage Temperature Range	$T_{STG}$	-55 to 150	$^\circ C$
Operating Junction Temperature Range	$T_J$	-55 to 150	$^\circ C$
Thermal Resistance Junction-Ambient <sup>1</sup>	$R_{\theta JA}$	75	$^\circ C/W$
Thermal Resistance Junction-Case <sup>1</sup>	$R_{\theta JC}$	4.8	$^\circ C/W$

### ➤ Electrical Characteristics ( $T_J=25^\circ C$ Unless otherwise noted)

Parameter	Symbol	Conditions	Min.	Typ.	Max.	Unit
Drain-Source Breakdown Voltage	$BV_{DSS}$	$V_{GS}=0V, I_D=250\mu A$	30	---	---	V
BVDSS Temperature Coefficient	$\Delta BV_{DSS}/\Delta T_J$	Reference to $25^\circ C, I_D=1mA$	---	0.023	---	$V/^\circ C$
Static Drain-Source On-Resistance <sup>2</sup>	$R_{DS(ON)}$	$V_{GS}=10V, I_D=15A$	---	---	12	$m\Omega$
		$V_{GS}=4.5V, I_D=10A$	---	---	16.5	
Gate Threshold Voltage	$V_{GS(th)}$	$V_{GS}=V_{DS}, I_D=250\mu A$	1.0	---	2.5	V
$V_{GS(th)}$ Temperature Coefficient	$\Delta V_{GS(th)}$		---	-5.08	---	$mV/^\circ C$
Drain-Source Leakage Current	$I_{DSS}$	$V_{DS}=24V, V_{GS}=0V, T_J=25^\circ C$	---	---	1	$\mu A$
		$V_{DS}=24V, V_{GS}=0V, T_J=55^\circ C$	---	---	5	
Gate-Source Leakage Current	$I_{GSS}$	$V_{GS}=\pm 20V, V_{DS}=0V$	---	---	$\pm 100$	nA
Forward Transconductance	$g_{fs}$	$V_{DS}=5V, I_D=15A$	---	24.4	---	S
Gate Resistance	$R_g$	$V_{DS}=0V, V_{GS}=0V, f=1MHz$	---	1.8	---	$\Omega$
Total Gate Charge (4.5V)	$Q_g$	$V_{DS}=15V, V_{GS}=4.5V, I_D=12A$	---	9.82	---	nC
Gate-Source Charge	$Q_{gs}$		---	2.24	---	
Gate-Drain Charge	$Q_{gd}$		---	5.54	---	
Turn-On Delay Time	$T_{d(on)}$	$V_{DD}=15V, V_{GS}=10V, R_G=1.5\Omega$ $I_D=20A$	---	6.4	---	ns
Rise Time	$T_r$		---	39	---	
Turn-Off Delay Time	$T_{d(off)}$		---	21	---	
Fall Time	$T_f$		---	4.7	---	
Input Capacitance	$C_{iss}$	$V_{DS}=15V, V_{GS}=0V, f=1MHz$	---	896	---	pF
Output Capacitance	$C_{oss}$		---	126	---	
Reverse Transfer Capacitance	$C_{rss}$		---	108	---	

### ➤ Diode Characteristics

Parameter	Symbol	Conditions	Min.	Typ.	Max.	Unit
Continuous Source Current <sup>1,5</sup>	$I_S$	$V_G=V_D=0V, \text{Force Current}$	---	---	37	A
Pulsed Source Current <sup>2,5</sup>	$I_{SM}$		---	---	75	A
Diode Forward Voltage <sup>2</sup>	$V_{SD}$	$V_{GS}=0V, I_S=1A, T_J=25^\circ C$	---	---	1	V

Note :

- 1.Pulse width limited by maximum junction temperature.
- 2.The data tested by pulsed , pulse width  $\leq 300\mu s$  , duty cycle  $\leq 2\%$
- 3.The EAS data shows Max. rating . The test condition is  $V_{DD}=25V, V_{GS}=10V, L=0.1mH, I_{AS}=22A$
- 4.Ensure that the channel temperature does not exceed  $150^\circ C$ .
- 5.The data is theoretically the same as  $I_D$  and  $I_{DM}$  , in real applications , should be limited by total power dissipation.

### ➤ Typical Characteristics

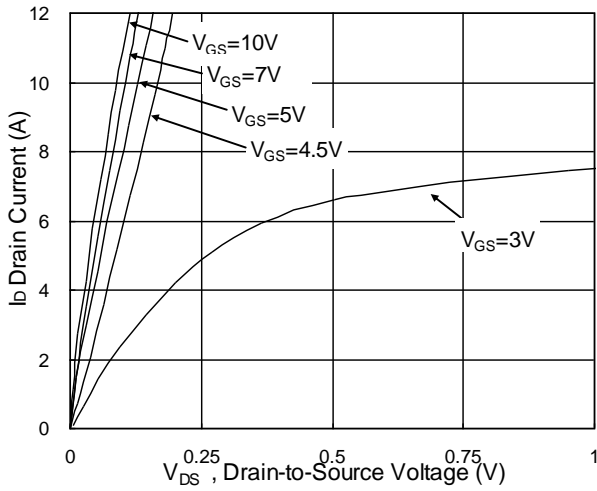

**Fig.1 Typical Output Characteristics**

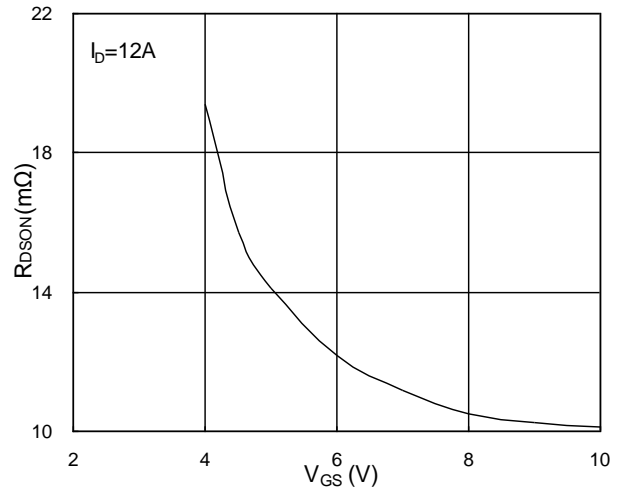

**Fig.2 On-Resistance vs. G-S Voltage**

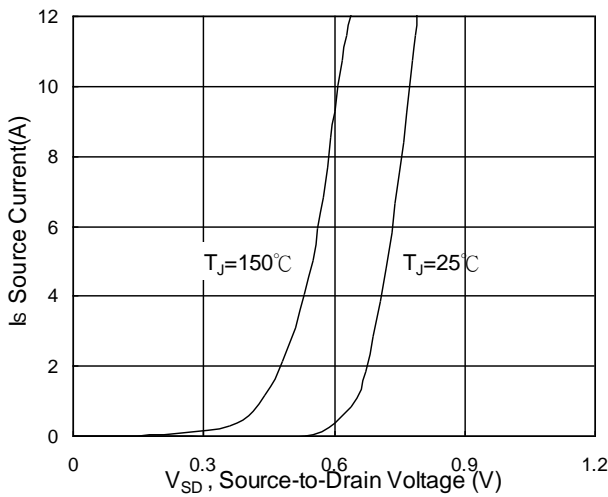

**Fig.3 Forward Characteristics of Reverse**

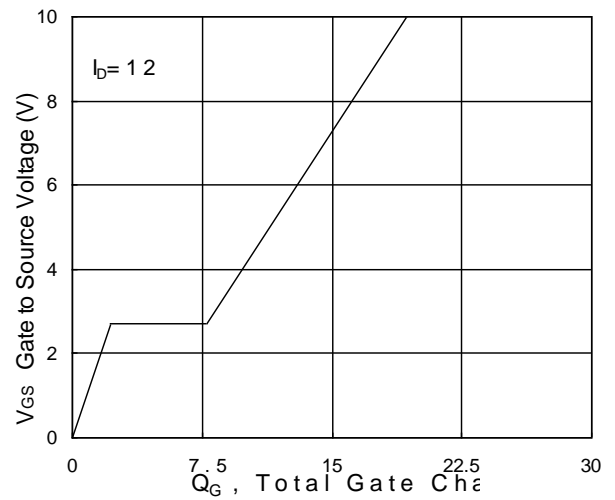

**Fig.4 Gate-charge Characteristics**

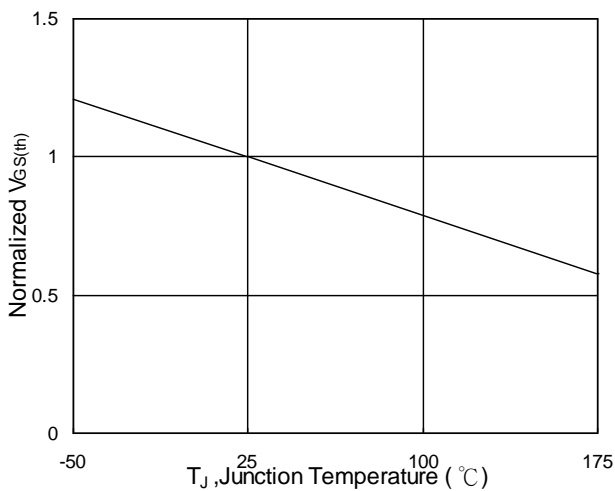

**Fig.5 Normalized  $V_{GS(th)}$  vs.  $T_J$**

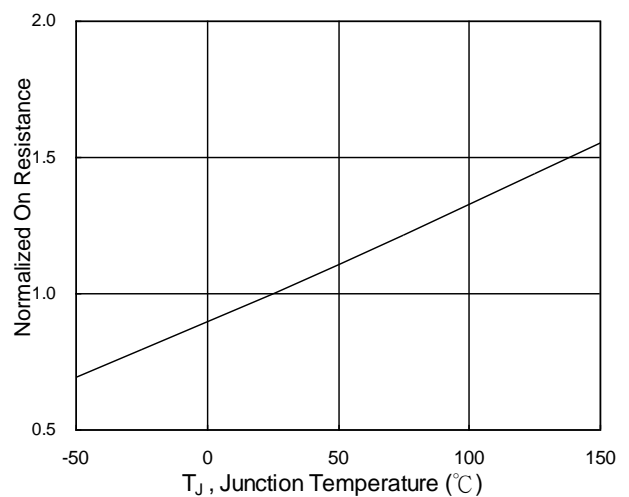

**Fig.6 Normalized  $R_{DS(on)}$  vs.  $T_J$**

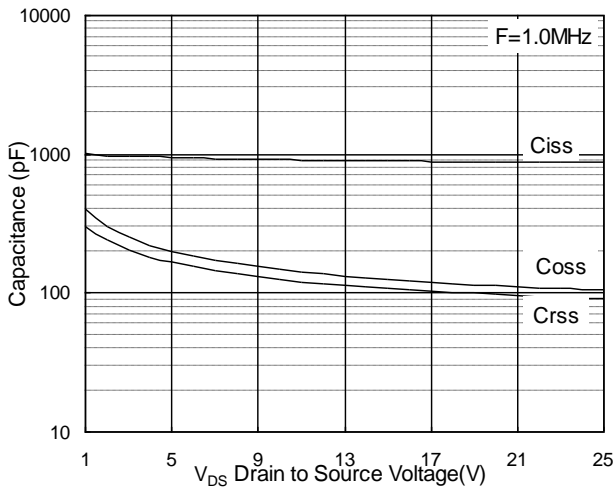

**Fig.7 Capacitance**

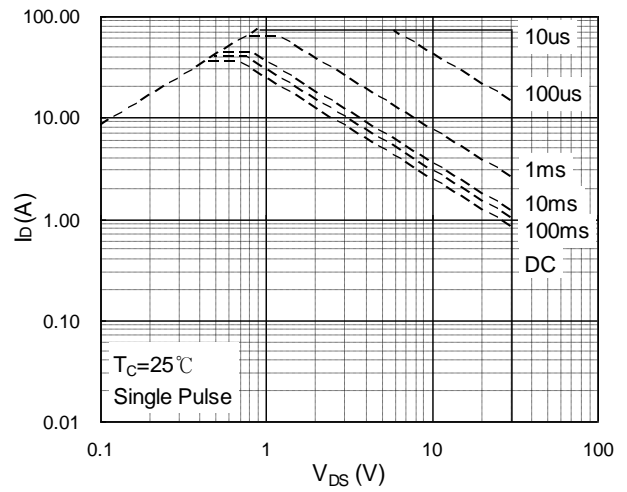

**Fig.8 Safe Operating Area**

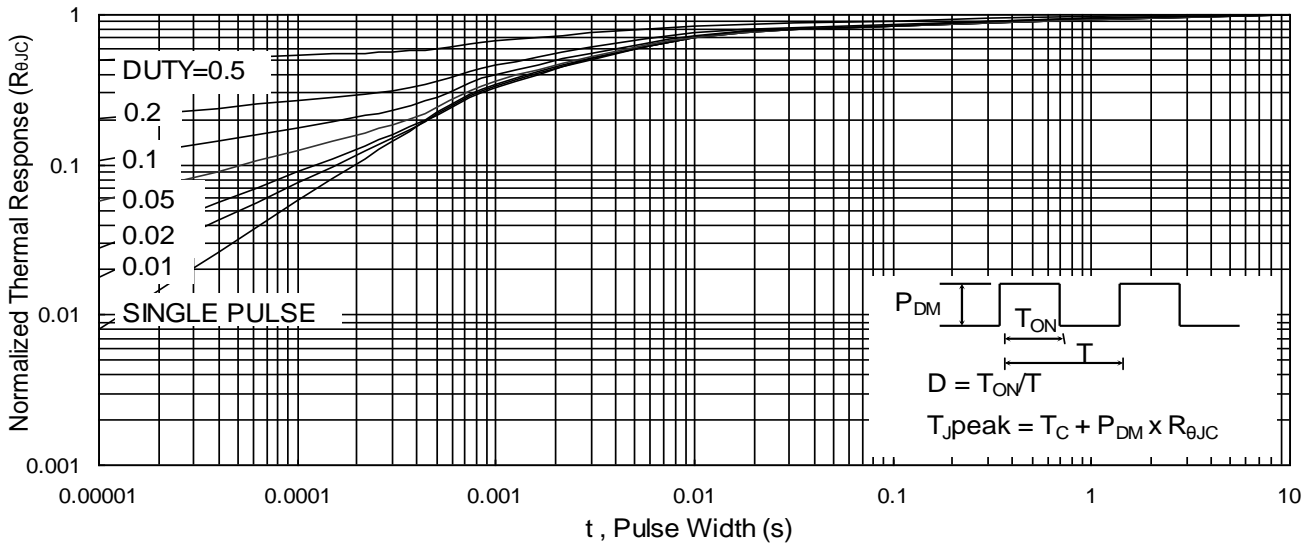

**Fig.9 Normalized Maximum Transient Thermal Impedance**

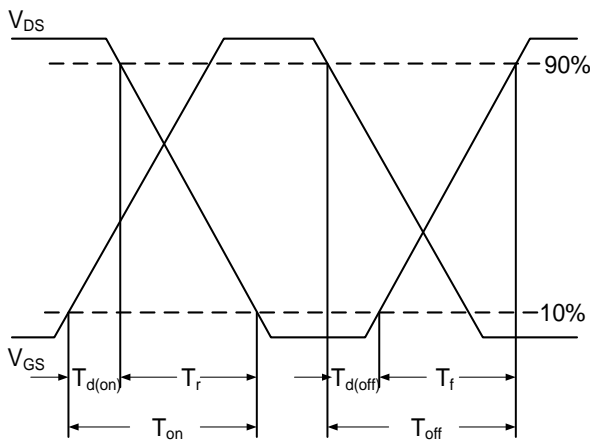

**Fig.10 Switching Time Waveform**

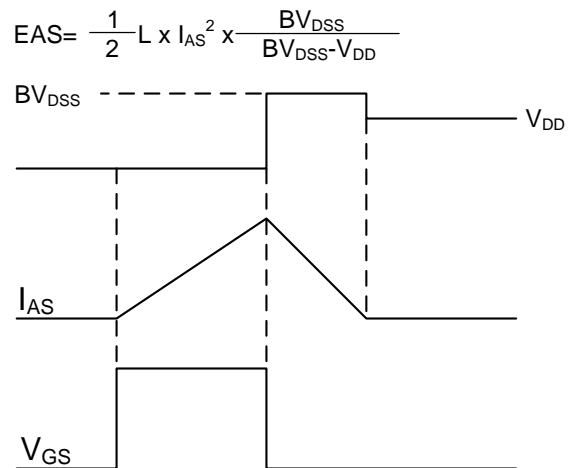

**Fig.11 Unclamped Inductive Waveform**

## ➤ Recommand IR Reflow Soldering Thermal Profile



Profile Feature	Pb-Free Assembly Profile
Temperature Min. (T <sub>smin</sub> )	150°C
Temperature Max. (T <sub>smax</sub> )	200°C
Time (t <sub>s</sub> ) from (T <sub>smin</sub> to T <sub>smax</sub> )	60-120 seconds
Average Ramp-up Rate (t <sub>L</sub> to t <sub>P</sub> )	3°C/second max.
Liquidous Temperature (T <sub>L</sub> )	217°C
Time (t <sub>L</sub> ) Maintained Above (T <sub>L</sub> )	60 – 150 seconds
Peak Temperature	260°C +0°C / -5°C
Time (t <sub>P</sub> ) within 5°C of actual Peak Temperature	30 seconds
Ramp-down Rate (T <sub>P</sub> to T <sub>L</sub> )	6°C/second max
Time 25°C to Peak Temperature	8 minutes max.

## ➤ Ordering Information

Part Number	Description	Quantity
PAN30TV14V	DFN3X3A-EP1 Reel	3000 pcs

### ➤ Package Information (DFN3X3A-EP1)

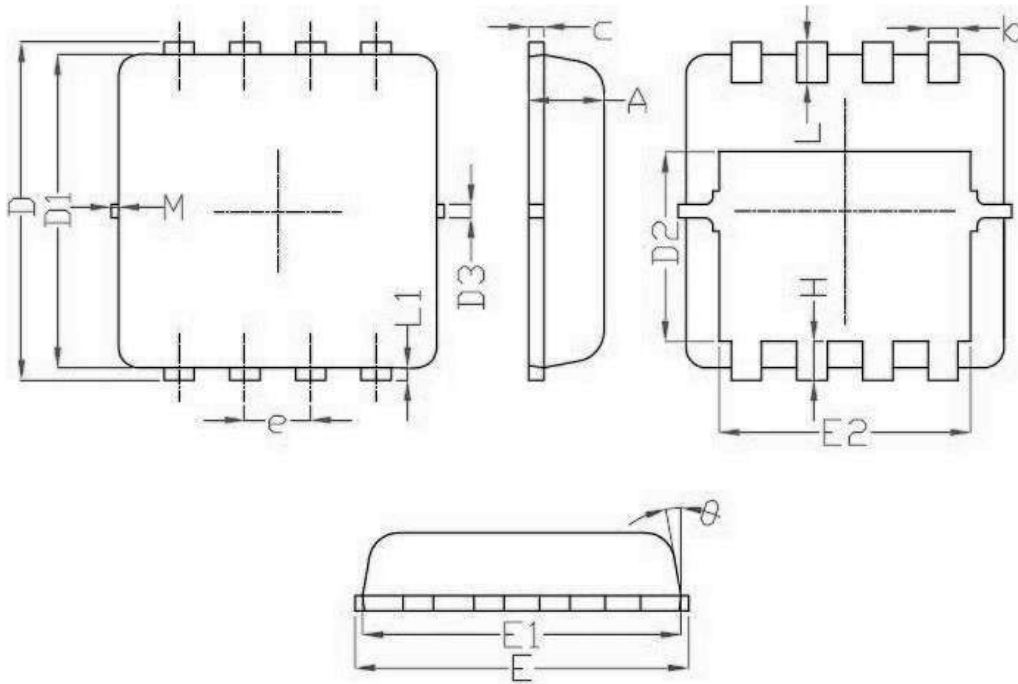

SYMBOLS	MILLIMETERS		INCHES	
	MIN	MAX	MIN	MAX
A	0.70	0.85	0.027	0.034
b	0.20	0.40	0.007	0.016
c	0.10	0.25	0.004	0.010
D	3.15	3.45	0.124	0.136
D1	2.90	3.20	0.114	0.126
D2	1.54	1.98	0.060	0.080
D3	0.10	0.30	0.004	0.012
E	3.15	3.45	0.124	0.136
E1	3.00	3.25	0.118	0.128
E2	2.29	2.65	0.090	0.104
e	0.65 BSC		0.025 BSC	
H	0.28	0.65	0.011	0.026
Θ	0°	14°	0°	14°
L	0.30	0.50	0.012	0.020
L1	0.13		0.005	
M	---	0.15	---	0.006

## DISCLAIMER

- The information in this document and any product described herein are subject to change without notice and should not be construed as a commitment by Paceleader, Paceleader reserve the right to make changes to the information in this document.
- Though Paceleader make effort to improve product quality and reliability, Product can malfunction and fail due to their inherent electrical sensitivity and vulnerability to physical stress, it is the responsibility of the customer, when utilizing Paceleader products, to comply with the standards of safety in making a safe design for entire system and to avoid situation in which a malfunction or failure., In developing a new designs, customer should ensure that the device which shown in this documents are used within specified operatingranges.
- The information contained herein is presented only as a guide for the applications of our products. No responsibility is assumed by Paceleader for any infringements of patents or other rights of the third parties which may result from its use.