

➤ General Description

This PAN2020EW N-Channel enhancement mode power field effect transistor is the high density trench technology and this advanced technology can provide excellent $R_{ds(On)}$ performance and efficiency for power switching and load switching application., this device also comply with the RoHS and Green Product requirement with full function reliability approved.

➤ Feature

- Low Offset (Error) Voltage
- Low-Voltage Operation
- High-Speed Circuits
- ESD Protection
- Low Battery Voltage Operation
- SOT-723 package design

➤ SOT-723

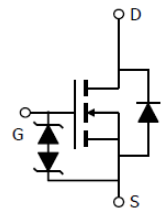
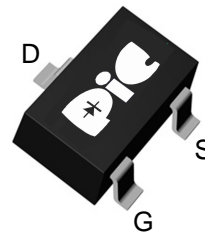

➤ Application

- Drivers: Relays, Solenoids, Lamps, Hammers, Displays, Memories
- Battery Operated Systems
- Power Supply Converter Circuits
- Load/Power Switching Smart Phones, Pagers

➤ Absolute Maximum Ratings

Parameter	Symbol	Rating	Unit
Drain-Source Voltage	V_{DSS}	20	V
Gate-Source Voltage	V_{GSS}	± 12	V
Continuous Drain Current($T_J=150^\circ C$)	I_D	$T_A=25^\circ C$	0.7
		$T_A=70^\circ C$	0.4
Pulsed Drain Current	I_{DM}	1.0	A
Continuous Source Current(Diode Conduction)	I_S	0.3	A
Power Dissipation	P_D	$T_A=25^\circ C$	0.27
		$T_A=70^\circ C$	0.16
Operating Junction Temperature	T_J	-55/150	$^\circ C$
Storage Temperature Range	T_{STG}	-55/150	$^\circ C$

➤ Electrical Characteristics ($T_A=25^\circ C$ Unless otherwise noted)

Parameter	Symbol	Conditions	Min.	Typ	Max.	Unit
Static						
Drain-Source Breakdown Voltage	$V_{(BR)DSS}$	$V_{GS}=0V, I_D=250\mu A$	20			V
Gate Threshold Voltage	$V_{GS(th)}$	$V_{DS}=V_{GS}, I_D=250\mu A$	0.3		1.0	V
Gate Leakage Current	I_{GSS}	$V_{DS}=0V, V_{GS}=\pm 12V$			± 1	mA
Zero Gate Voltage Drain Current	I_{DSS}	$V_{DS}=20V, V_{GS}=0V$			1	uA
		$V_{DS}=20V, V_{GS}=0V$ $T_J=85^\circ C$			5	
On-State Drain Current	$I_{D(on)}$	$V_{DS} \geq 5V, V_{GS}=4.5V$	0.7			A
Drain-Source On-Resistance	$R_{DS(on)}$	$V_{GS}=4.5V, I_D=0.8A$		300	360	m Ω
		$V_{GS}=2.5V, I_D=0.7A$		340	420	
		$V_{GS}=1.8V, I_D=0.6A$		420	560	
Forward Transconductance	g_{FS}	$V_{DS}=10V, I_D=0.4A$		1		S
Diode Forward Voltage	V_{SD}	$I_S=0.15A, V_{GS}=0V$		0.65	1.2	V
Dynamic						
Input Capacitance	C_{iss}	$V_{DS}=10V, V_{GS}=0V$ $f=1MHz$		70		pF
Output Capacitance	C_{oss}			20		
Reverse Transfer Capacitance	C_{rss}			8		
Total Gate Charge	Q_g	$V_{DS}=10V, V_{GS}=4.5V$ $I_D \approx 0.6A$		1.06	1.38	nC
Gate-Source Charge	Q_{gs}			0.18		
Gate-Drain Charge	Q_{gd}			0.32		
Turn-On Time	$t_{d(on)}$	$V_{DD}=10V, R_L=20\Omega$ $I_D \approx 0.5A, V_{GEN}=4.5V$ $R_G=1\Omega$		18	26	ns
	t_r			20	28	
Turn-Off Time	$t_{d(off)}$			70	110	
	t_f			25	40	

➤ Typical Characteristics

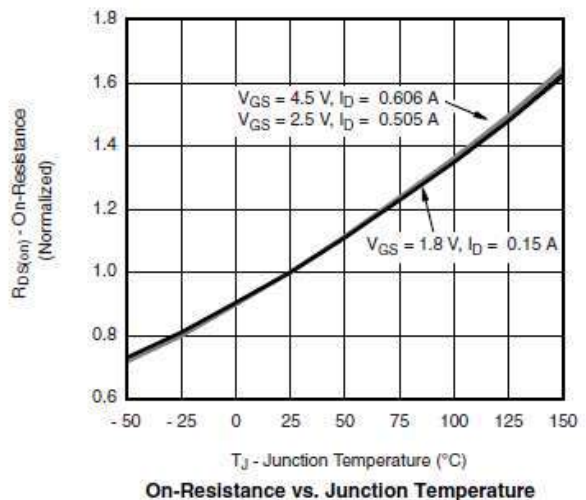
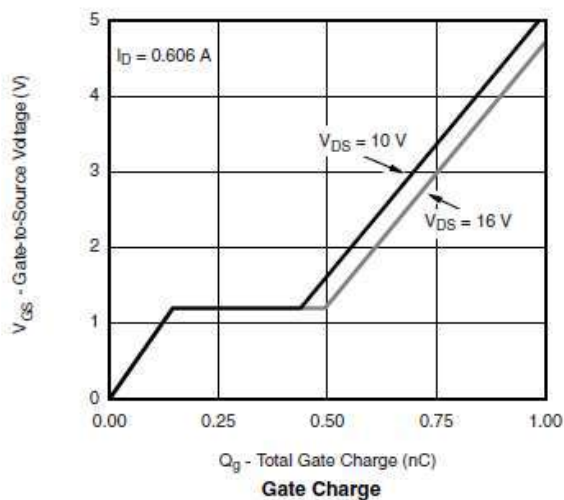
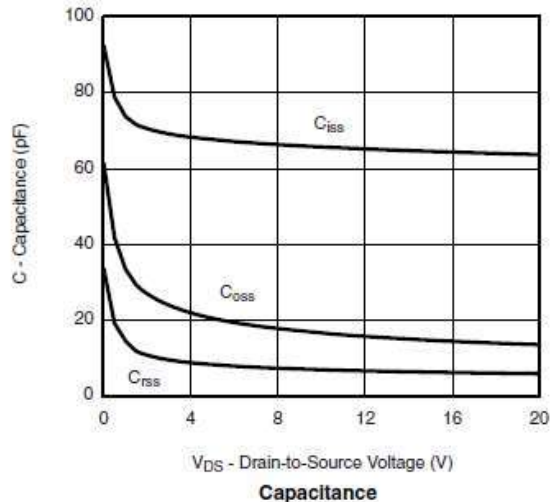
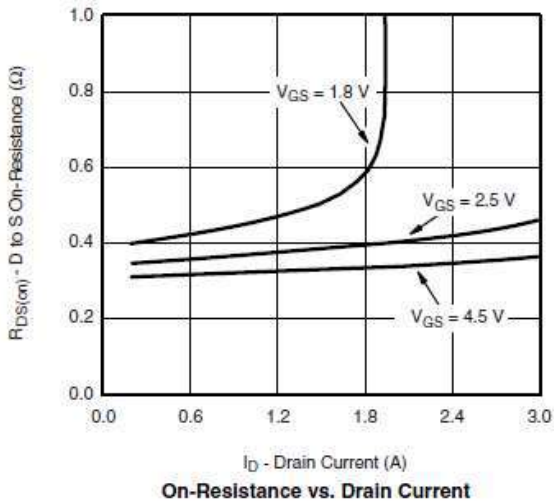
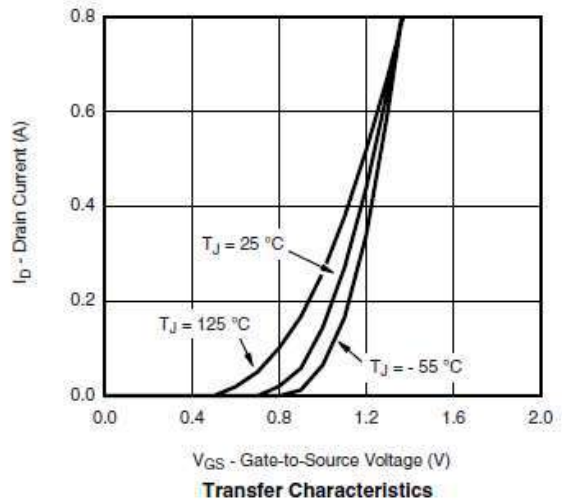
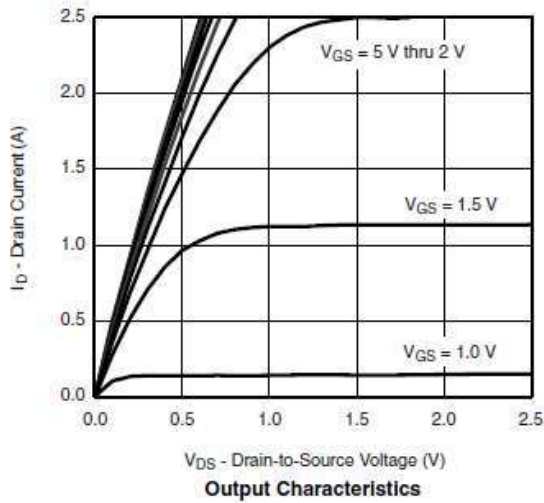

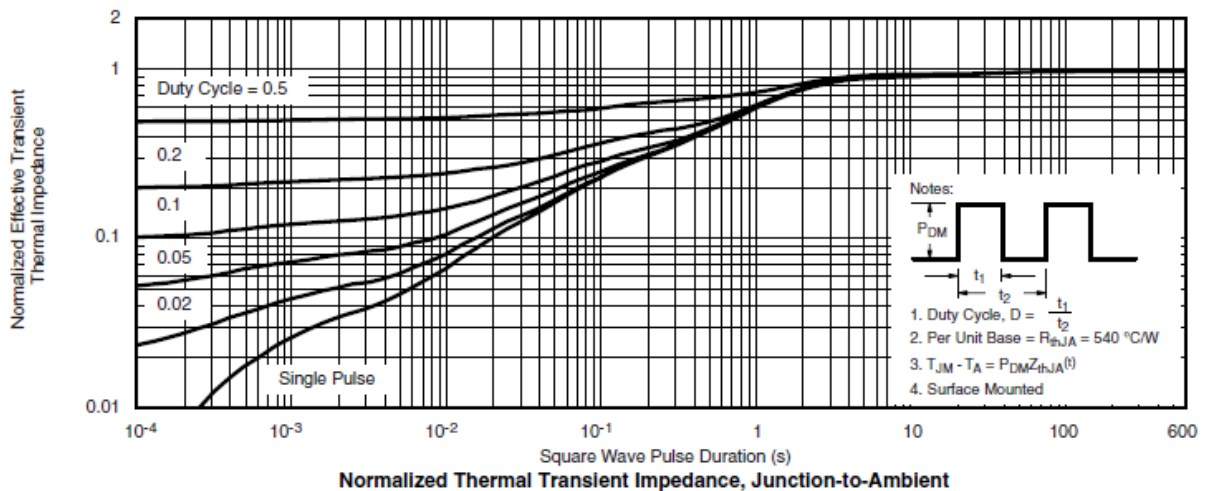
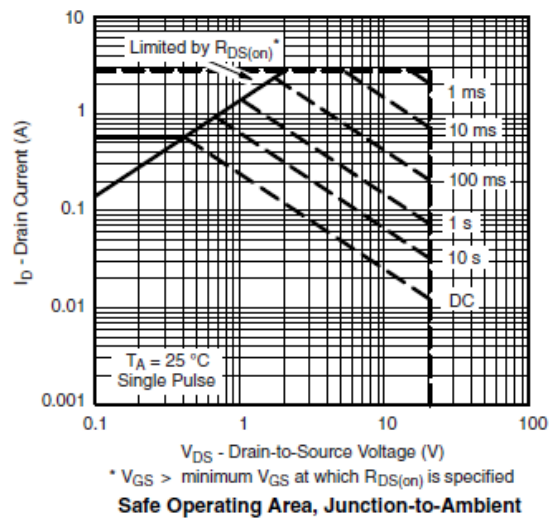
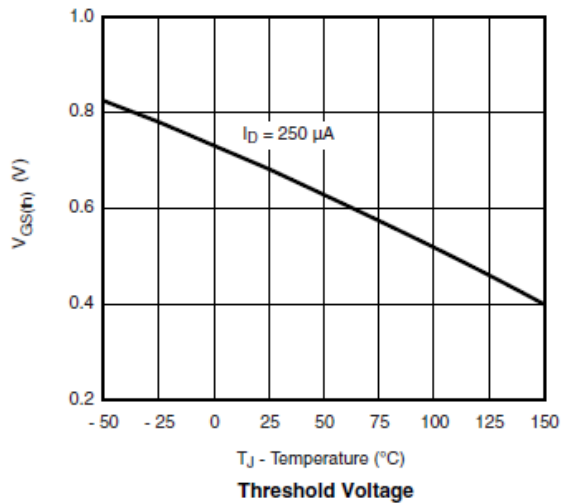
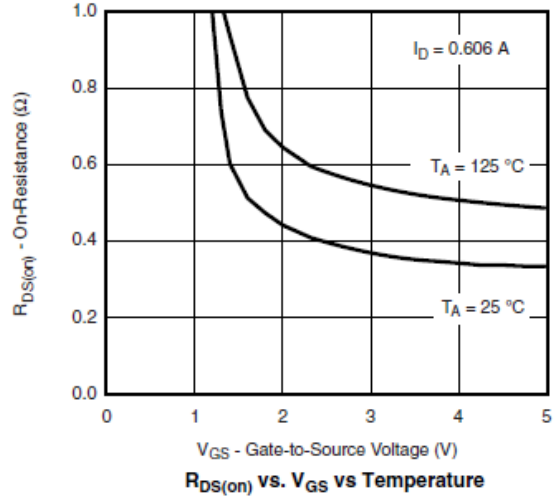
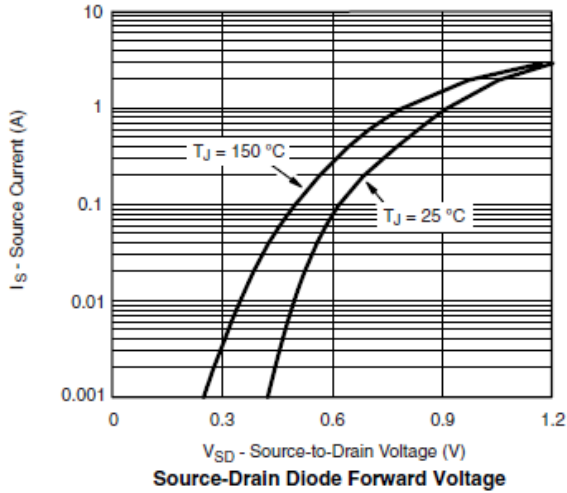

➤ Recommend IR Reflow Soldering Thermal Profile

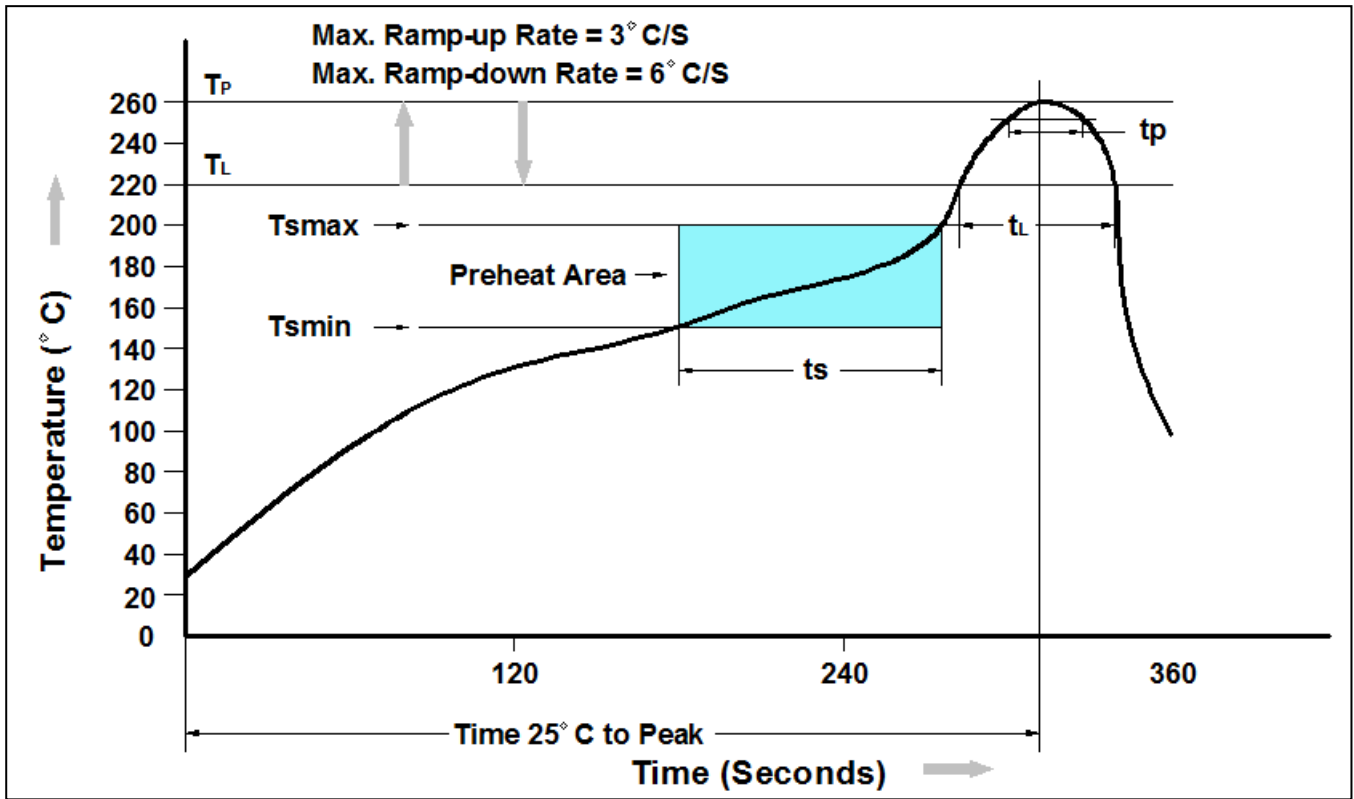

Profile Feature	Pb-Free Assembly Profile
Temperature Min. (T_{smin})	150°C
Temperature Max. (T_{smax})	200°C
Time (t_s) from (T_{smin} to T_{smax})	60-120 seconds
Average Ramp-up Rate (t_L to t_P)	3°C/second max.
Liquidous Temperature (T_L)	217°C
Time (t_L) Maintained Above (T_L)	60 – 150 seconds
Peak Temperature	260°C +0°C / -5°C
Time (t_P) within 5°C of actual Peak Temperature	30 seconds
Ramp-down Rate (T_P to T_L)	6°C/second max
Time 25°C to Peak Temperature	8 minutes max.

➤ Ordering Information

Part Number	Description	Quantity
PAN2020EW	SOT-723 Reel	8000 pcs

➤ Package Information (SOT-723)

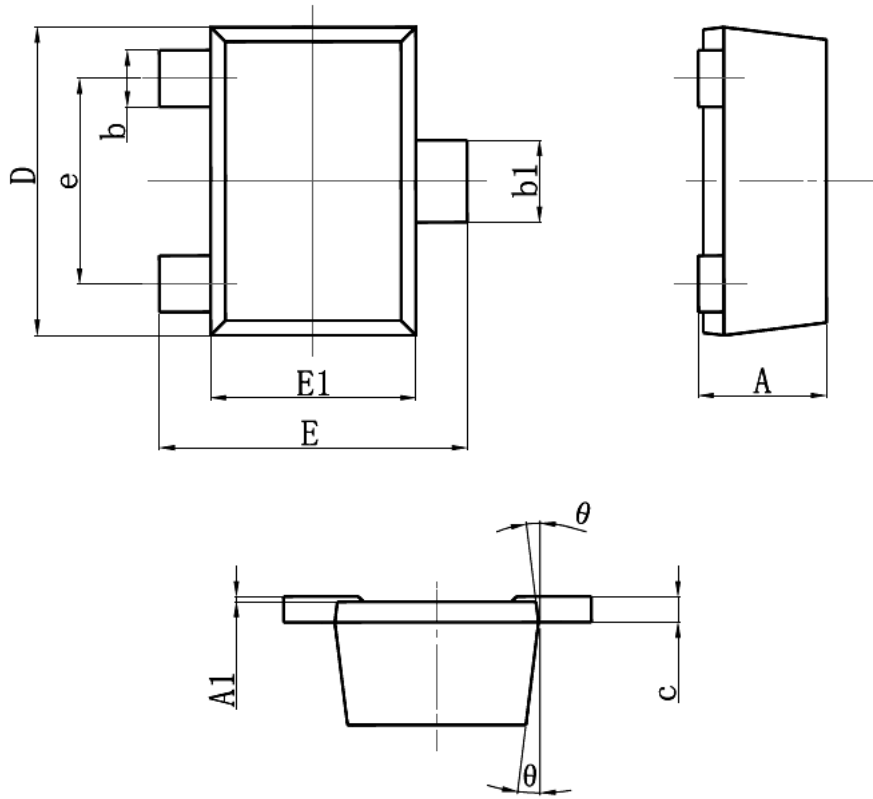

Symbol	Dimensions In Millimeters		Dimensions In Inches	
	Min.	Max.	Min.	Max.
A		0.500		0.020
A1	0.000	0.050	0.000	0.002
b	0.170	0.270	0.007	0.011
b1	0.270	0.370	0.011	0.015
c		0.150		0.006
D	1.150	1.250	0.045	0.049
E	1.150	1.250	0.045	0.049
E1	0.750	0.850	0.030	0.033
e	0.800TYP.		0.031TYP.	
θ	7° REF.		7° REF.	

DISCLAIMER

- The information in this document and any product described herein are subject to change without notice and should not be construed as a commitment by Paceleader, Paceleader reserve the right to make changes to the information in this document.
- Though Paceleader make effort to improve product quality and reliability, Product can malfunction and fail due to their inherent electrical sensitivity and vulnerability to physical stress, it is the responsibility of the customer, when utilizing Paceleader products, to comply with the standards of safety in making a safe design for entire system and to avoid situation in which a malfunction or failure., In developing a new designs, customer should ensure that the device which shown in this documents are used within specified operatingranges.
- The information contained herein is presented only as a guide for the applications of our products. No responsibility is assumed by Paceleader for any infringements of patents or other rights of the third parties which may result from its use.