

## N-Ch and P-Ch Fast Switching MOSFET

$V_{DS}=40V$ ,  $I_D=23A$ ,  $R_{DS(ON)}=28m\Omega$

$V_{DS}=-40V$ ,  $I_D=-20A$ ,  $R_{DS(ON)}=40m\Omega$

### ➤ General Description

This PAC49TX03X N&P Channel enhancement mode power field effect transistor is the high density trench technology and this advanced technology can provide excellent  $R_{ds(On)}$  performance and efficiency for power switching and load switching application., this device also comply with the RoHS and Green Product requirement with full function reliability approved.

### ➤ Feature

- Super Low Gate Charge
- 100% EAS Guaranteed
- Green Device Available
- Excellent  $CdV/dt$  effect decline
- Advanced high cell density Trench technology

### ➤ TO-252-4L

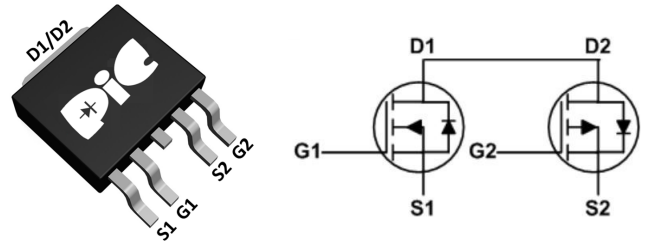

### ➤ Application

- Inverter
- H-Bridge

### ➤ Absolute Maximum Ratings

Parameter	Symbol	Rating		Units
		N-Ch	P-Ch	
Drain-Source Voltage	$V_{DS}$	40	-40	V
Gate-Source Voltage	$V_{GS}$	$\pm 20$	$\pm 20$	V
Continuous Drain Current, $V_{GS} @ 10V^1$	$I_D @ T_C=25^\circ C$	23	-20	A
Continuous Drain Current, $V_{GS} @ 10V^1$	$I_D @ T_C=100^\circ C$	18	-16	A
Pulsed Drain Current <sup>2</sup>	$I_{DM}$	46	-40	A
Single Pulse Avalanche Energy <sup>3</sup>	EAS	28	66	mJ
Avalanche Current	$I_{AS}$	17.8	-27.2	A
Total Power Dissipation <sup>4</sup>	$P_D @ T_C=25^\circ C$	25	31.3	W
Storage Temperature Range	$T_{STG}$	-55 to 150	-55 to 150	$^\circ C$
Operating Junction Temperature Range	$T_J$	-55 to 150	-55 to 150	$^\circ C$
Thermal Resistance Junction-Ambient <sup>1</sup>	$R_{\theta JA}$	62		$^\circ C/W$
Thermal Resistance Junction-Case <sup>1</sup>	$R_{\theta JC}$	5		$^\circ C/W$

## N-Ch and P-Ch Fast Switching MOSFET

$V_{DS}=40V, I_D=23A, R_{DS(ON)}=28m\Omega$

$V_{DS}=-40V, I_D=-20A, R_{DS(ON)}=40m\Omega$

### ➤ N-Channel Electrical Characteristics (T<sub>J</sub>=25°C Unless otherwise noted)

Parameter	Symbol	Conditions	Min.	Typ.	Max.	Unit
Drain-Source Breakdown Voltage	$BV_{DSS}$	$V_{GS}=0V, I_D=250\mu A$	40	---	---	V
BVDSS Temperature Coefficient	$\Delta BV_{DSS}/\Delta T_J$	Reference to 25°C, $I_D=1mA$	---	0.034	---	V/°C
Static Drain-Source On-Resistance <sup>2</sup>	$R_{DS(ON)}$	$V_{GS}=10V, I_D=12A$	---	---	28	mΩ
		$V_{GS}=4.5V, I_D=10A$	---	---	42	
Gate Threshold Voltage	$V_{GS(th)}$	$V_{GS}=V_{DS}, I_D=250\mu A$	1.0	1.5	2.5	V
$V_{GS(th)}$ Temperature Coefficient	$\Delta V_{GS(th)}$		---	-4.56	---	mV/°C
Drain-Source Leakage Current	$I_{DSS}$	$V_{DS}=32V, V_{GS}=0V, T_J=25^\circ C$	---	---	1	uA
		$V_{DS}=32V, V_{GS}=0V, T_J=55^\circ C$	---	---	5	
Gate-Source Leakage Current	$I_{GSS}$	$V_{GS}=\pm 20V, V_{DS}=0V$	---	---	±100	nA
Forward Transconductance	$g_{fs}$	$V_{DS}=5V, I_D=12A$	---	8	---	S
Gate Resistance	$R_g$	$V_{DS}=0V, V_{GS}=0V, f=1MHz$	---	2.6	5.2	Ω
Total Gate Charge (4.5V)	$Q_g$	$V_{DS}=20V, V_{GS}=4.5V, I_D=12A$	---	5.5	---	nC
Gate-Source Charge	$Q_{gs}$		---	1.25	---	
Gate-Drain Charge	$Q_{gd}$		---	2.5	---	
Turn-On Delay Time	$T_{d(on)}$	$V_{DD}=20V, V_{GS}=10V, R_G=3.3\Omega, I_D=1A$	---	8.9	---	ns
Rise Time	$T_r$		---	2.2	---	
Turn-Off Delay Time	$T_{d(off)}$		---	41	---	
Fall Time	$T_f$		---	2.7	---	
Input Capacitance	$C_{iss}$	$V_{DS}=15V, V_{GS}=0V, f=1MHz$	---	593	---	pF
Output Capacitance	$C_{oss}$		---	76	---	
Reverse Transfer Capacitance	$C_{rss}$		---	56	---	

### ➤ Diode Characteristics

Parameter	Symbol	Conditions	Min.	Typ.	Max.	Unit
Continuous Source Current <sup>1,5</sup>	$I_S$	$V_G=V_D=0V, \text{Force Current}$	---	---	23	A
Pulsed Source Current <sup>2,5</sup>	$I_{SM}$		---	---	46	A
Diode Forward Voltage <sup>2</sup>	$V_{SD}$	$V_{GS}=0V, I_S=1A, T_J=25^\circ C$	---	---	1.2	V

Note :

1. Pulse width limited by maximum junction temperature.
2. The data tested by pulsed, pulse width  $\leq 300\mu s$ , duty cycle  $\leq 2\%$
3. The EAS data shows Max. rating. The test condition is  $V_{DD}=25V, V_{GS}=10V, L=0.1mH, I_{AS}=17.8A$
4. Ensure that the channel temperature does not exceed 150°C.
5. The data is theoretically the same as ID and IDM, in real applications, should be limited by total power dissipation.

## N-Ch and P-Ch Fast Switching MOSFET

$V_{DS}=40V$ ,  $I_D=23A$ ,  $R_{DS(ON)}=28m\Omega$

$V_{DS}=-40V$ ,  $I_D=-20A$ ,  $R_{DS(ON)}=40m\Omega$

### ➤ P-Channel Electrical Characteristics (T<sub>J</sub>=25° C Unless otherwise noted)

Parameter	Symbol	Conditions	Min.	Typ.	Max.	Unit
Drain-Source Breakdown Voltage	$BV_{DSS}$	$V_{GS}=0V$ , $I_D=-250\mu A$	-40	---	---	V
$BV_{DSS}$ Temperature Coefficient	$\Delta BV_{DSS}/\Delta T_J$	Reference to 25°C, $I_D=-1mA$	---	-0.012	---	V/°C
Static Drain-Source On-Resistance <sup>2</sup>	$R_{DS(ON)}$	$V_{GS}=-10V$ , $I_D=-8A$	---	---	40	mΩ
		$V_{GS}=-4.5V$ , $I_D=-4A$	---	---	65	
Gate Threshold Voltage	$V_{GS(th)}$	$V_{GS}=V_{DS}$ , $I_D=-250\mu A$	-1.0	-1.6	-2.5	V
$V_{GS(th)}$ Temperature Coefficient	$\Delta V_{GS(th)}$		---	4.32	---	mV/°C
Drain-Source Leakage Current	$I_{DSS}$	$V_{DS}=-32V$ , $V_{GS}=0V$ , $T_J=25^\circ C$	---	---	1	uA
		$V_{DS}=-32V$ , $V_{GS}=0V$ , $T_J=55^\circ C$	---	---	5	
Gate-Source Leakage Current	$I_{GSS}$	$V_{GS}=\pm 20V$ , $V_{DS}=0V$	---	---	±100	nA
Forward Transconductance	$g_{fs}$	$V_{DS}=-5V$ , $I_D=-8A$	---	12.6	---	S
Gate Resistance	$R_g$	$V_{DS}=0V$ , $V_{GS}=0V$ , $f=1MHz$	---	13	16	Ω
Total Gate Charge (-4.5V)	$Q_g$	$V_{DS}=-20V$ , $V_{GS}=-4.5V$ , $I_D=-12A$	---	9	---	nC
Gate-Source Charge	$Q_{gs}$		---	2.54	---	
Gate-Drain Charge	$Q_{gd}$		---	3.1	---	
Turn-On Delay Time	$T_{d(on)}$	$V_{DD}=-15V$ , $V_{GS}=-10V$ , $R_G=3.3\Omega$ , $I_D=-1A$	---	19.2	---	ns
Rise Time	$T_r$		---	12.8	---	
Turn-Off Delay Time	$T_{d(off)}$		---	48.6	---	
Fall Time	$T_f$		---	4.6	---	
Input Capacitance	$C_{iss}$	$V_{DS}=-15V$ , $V_{GS}=0V$ , $f=1MHz$	---	1004	---	pF
Output Capacitance	$C_{oss}$		---	108	---	
Reverse Transfer Capacitance	$C_{rss}$		---	80	---	

### ➤ Diode Characteristics

Parameter	Symbol	Conditions	Min.	Typ.	Max.	Unit
Continuous Source Current <sup>1,5</sup>	$I_S$	$V_G=V_D=0V$ , Force Current	---	---	-20	A
Pulsed Source Current <sup>2,5</sup>	$I_{SM}$		---	---	-40	A
Diode Forward Voltage <sup>2</sup>	$V_{SD}$	$V_{GS}=0V$ , $I_S=-1A$ , $T_J=25^\circ C$	---	---	-1	V

Note :

1. Pulse width limited by maximum junction temperature.
2. The data tested by pulsed, pulse width  $\leq 300\mu s$ , duty cycle  $\leq 2\%$
3. The EAS data shows Max. rating. The test condition is  $V_{DD}=25V$ ,  $V_{GS}=10V$ ,  $L=0.1mH$ ,  $I_{AS}=-27.2A$
4. Ensure that the channel temperature does not exceed 150°C.
5. The data is theoretically the same as  $I_D$  and  $I_{DM}$ , in real applications, should be limited by total power dissipation.

## N-Ch and P-Ch Fast Switching MOSFET

$V_{DS}=40V$ ,  $I_D=23A$ ,  $R_{DS(ON)}=28m\Omega$

$V_{DS}=-40V$ ,  $I_D=-20A$ ,  $R_{DS(ON)}=40m\Omega$

### N-Channel Typical Characteristics

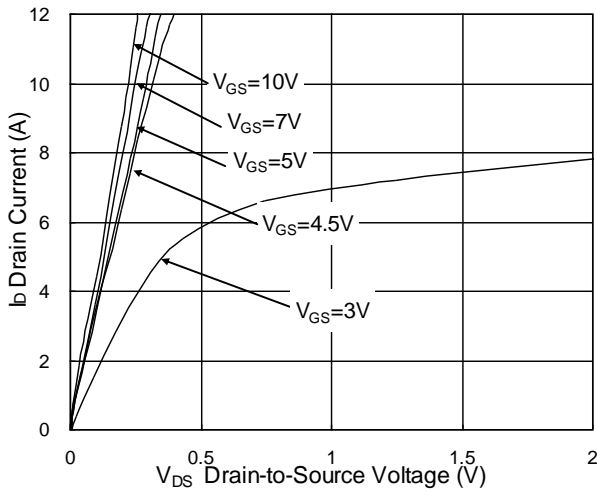

Fig.1 Typical Output Characteristics

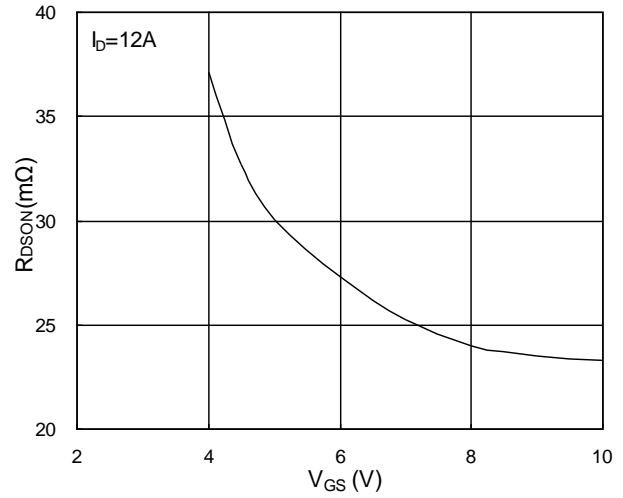

Fig.2 On-Resistance vs. G-S Voltage

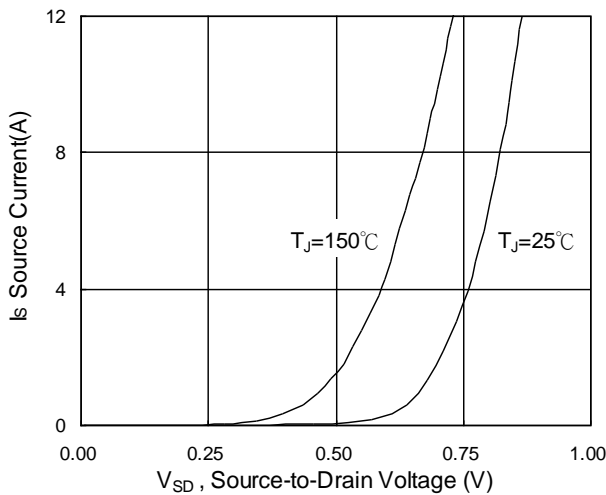

Fig.3 Forward Characteristics of Reverse

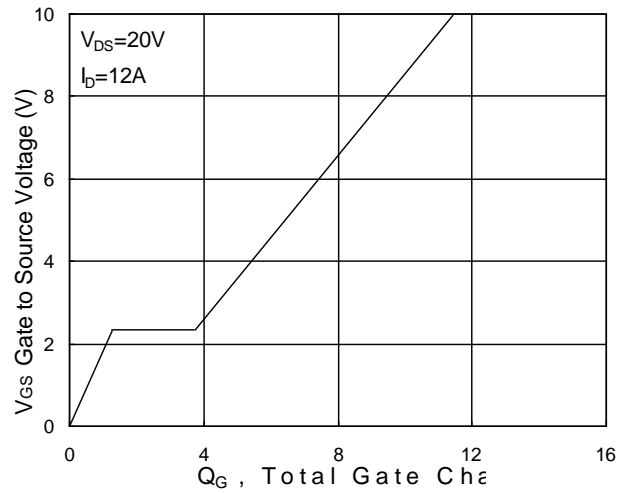

Fig.4 Gate-Charge Characteristics

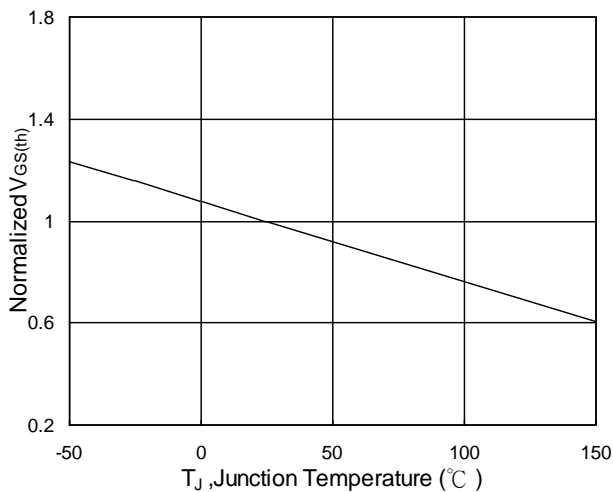

Fig.5 Normalized  $V_{GS(th)}$  vs.  $T_J$

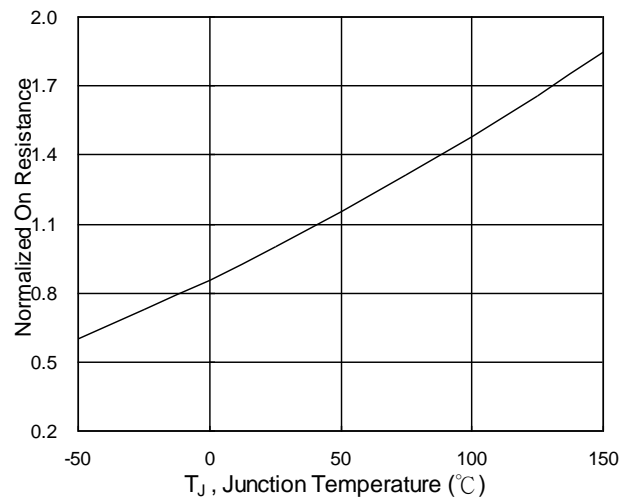
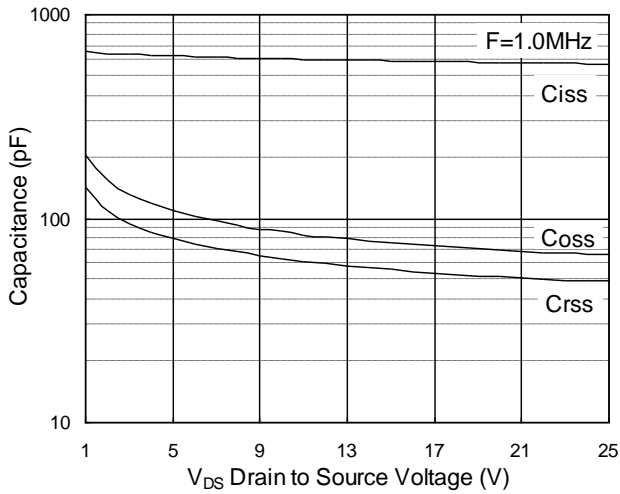

Fig.6 Normalized  $R_{DS(ON)}$  vs.  $T_J$

## N-Ch and P-Ch Fast Switching MOSFET

$V_{DS}=40V, I_D=23A, R_{DS(ON)}=28m\Omega$

$V_{DS}=-40V, I_D=-20A, R_{DS(ON)}=40m\Omega$



**Fig.7 Capacitance**

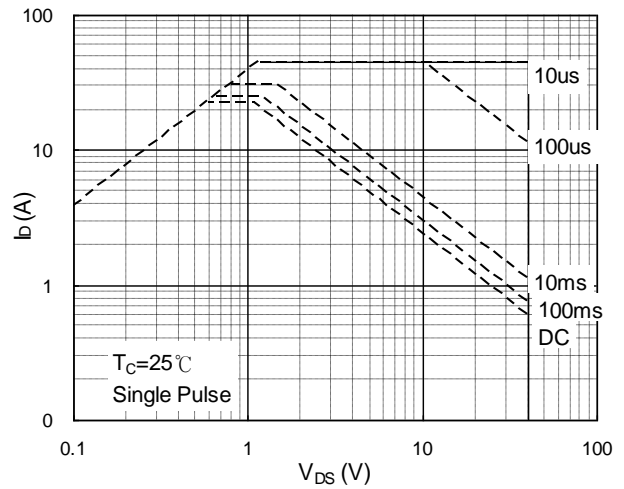

**Fig.8 Safe Operating Area**

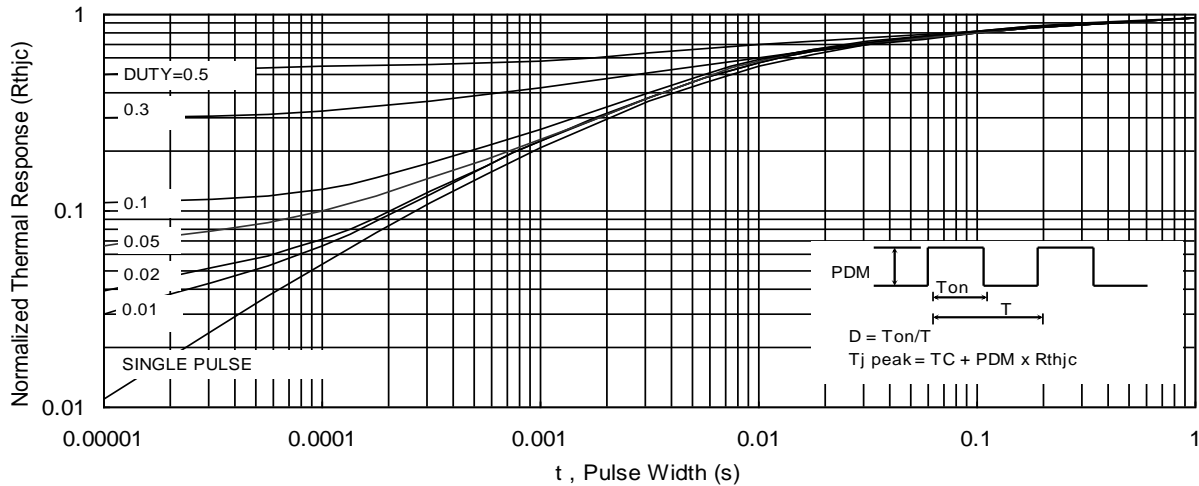

**Fig.9 Normalized Maximum Transient Thermal Impedance**

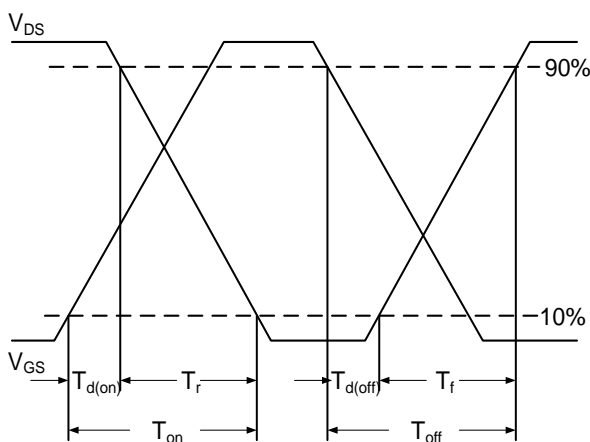

**Fig.10 Switching Time Waveform**

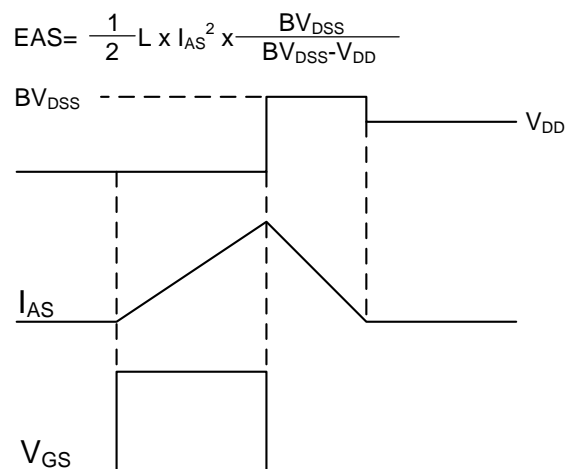

**Fig.11 Unclamped Inductive Switching Wave**

## N-Ch and P-Ch Fast Switching MOSFET

$V_{DS}=40V$ ,  $I_D=23A$ ,  $R_{DS(ON)}=28m\Omega$

$V_{DS}=-40V$ ,  $I_D=-20A$ ,  $R_{DS(ON)}=40m\Omega$

### P-Channel Typical Characteristics

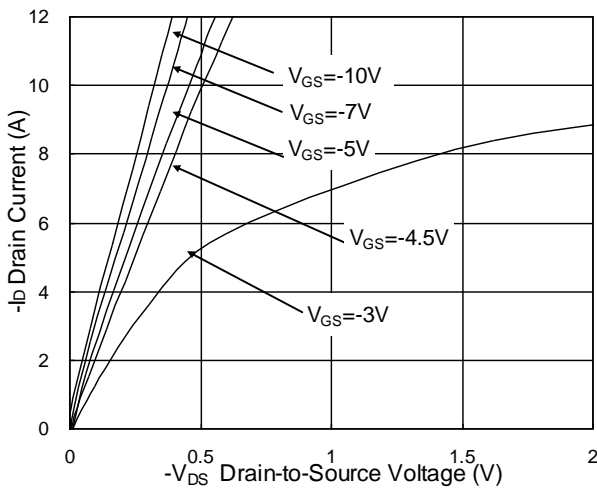

Fig.1 Typical Output Characteristics

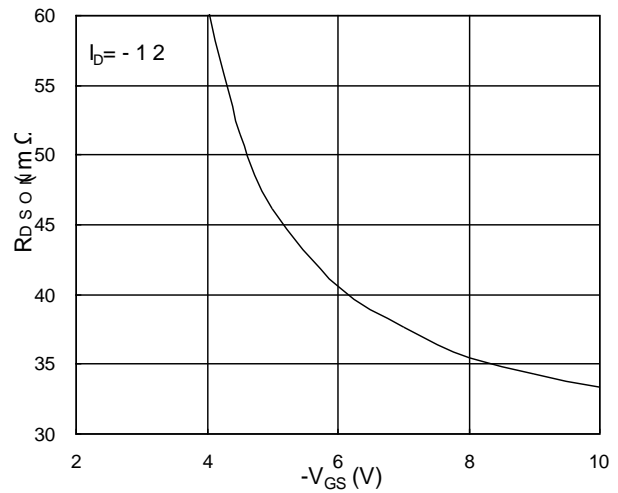

Fig.2 On-Resistance v.s Gate-Source

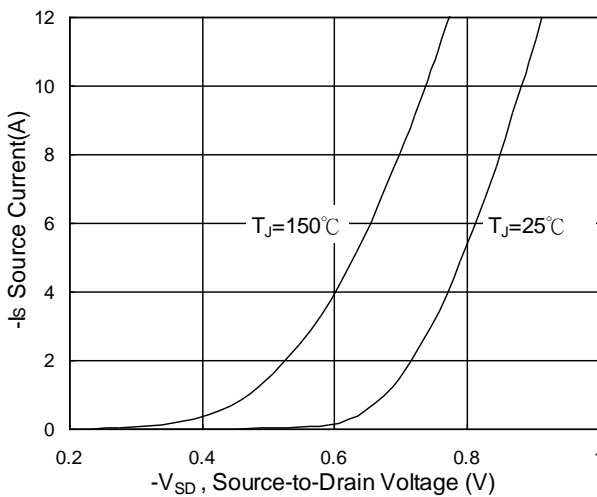

Fig.3 Forward Characteristics of Reverse

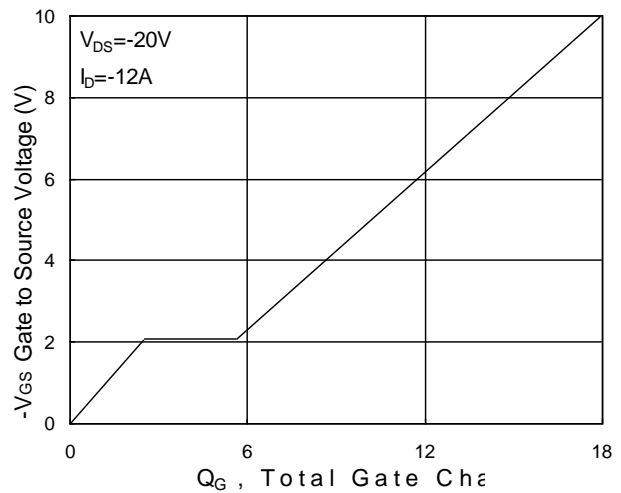

Fig.4 Gate-Charge Characteristics

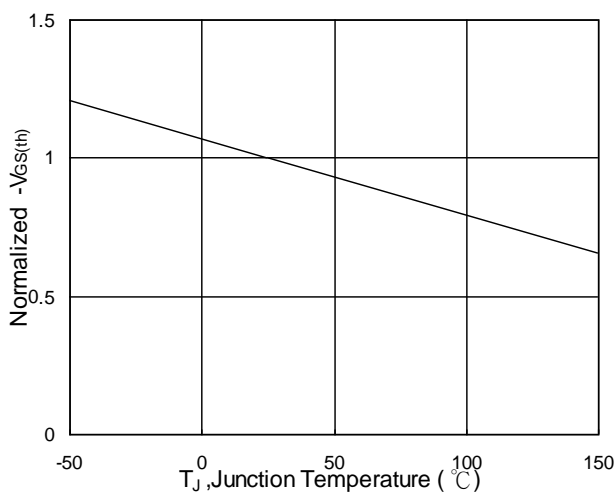

Fig.5 Normalized  $V_{GS(th)}$  v.s  $T_J$

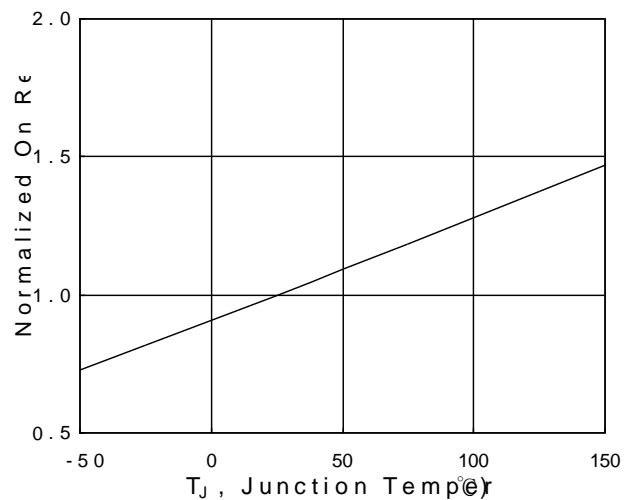
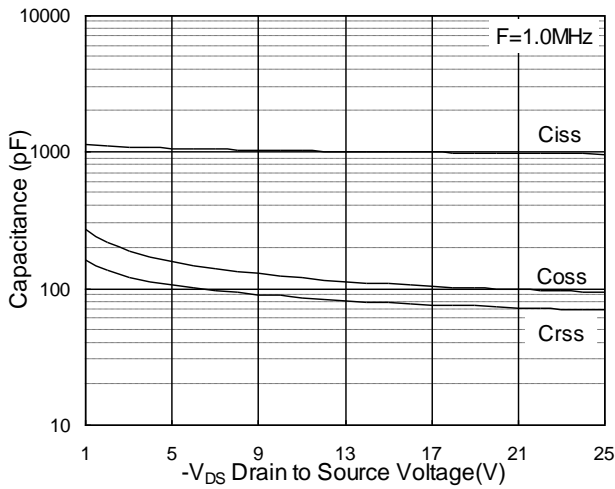

Fig.6 Normalized  $R_{DS(on)}$  v.s  $T_J$

## N-Ch and P-Ch Fast Switching MOSFET

$V_{DS}=40V$ ,  $I_D=23A$ ,  $R_{DS(ON)}=28m\Omega$

$V_{DS}=-40V$ ,  $I_D=-20A$ ,  $R_{DS(ON)}=40m\Omega$



**Fig.7 Capacitance**

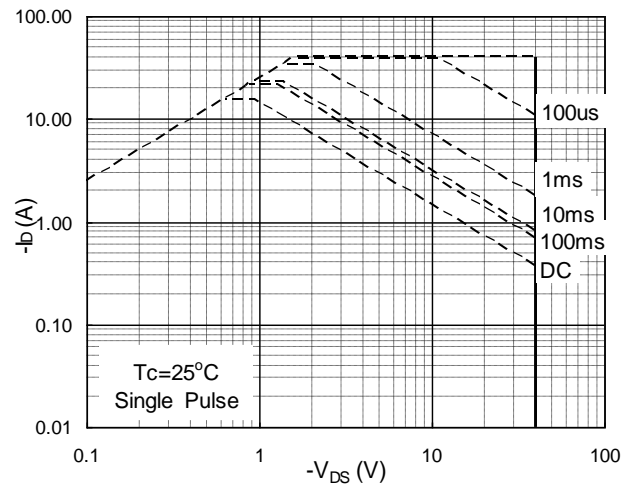

**Fig.8 Safe Operating Area**

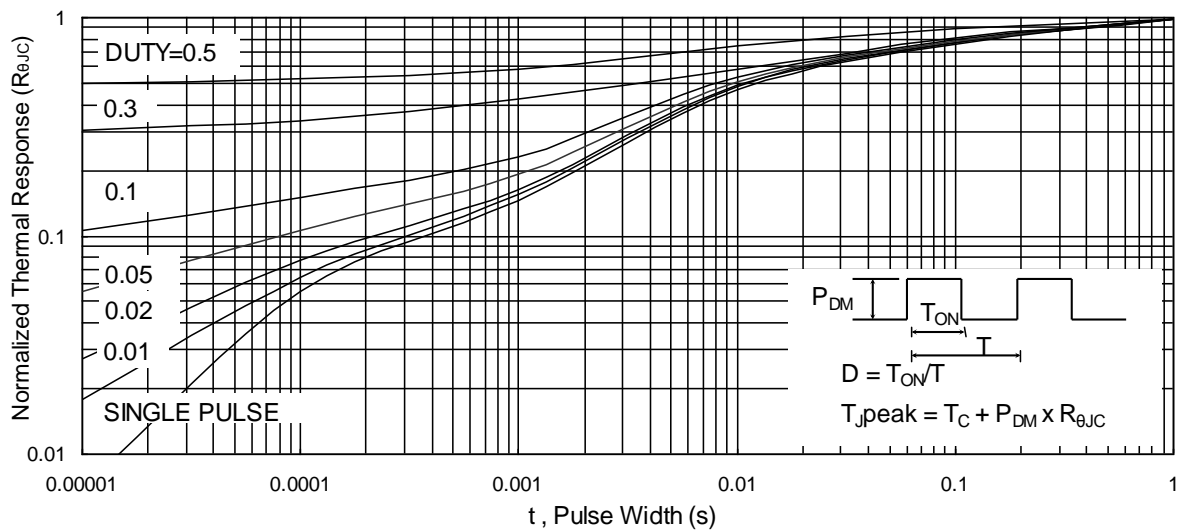

**Fig.9 Normalized Maximum Transient Thermal Impedance**

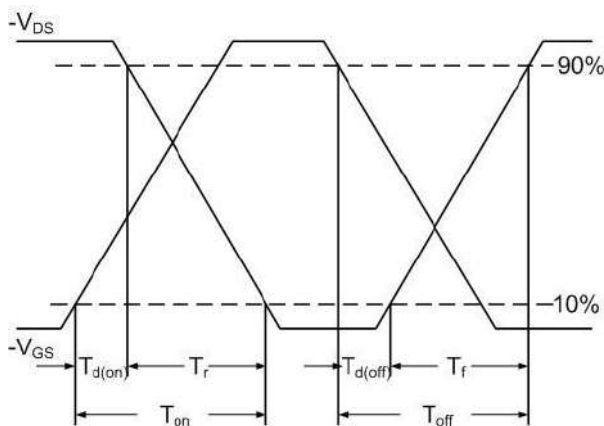

**Fig.10 Switching Time Waveform**

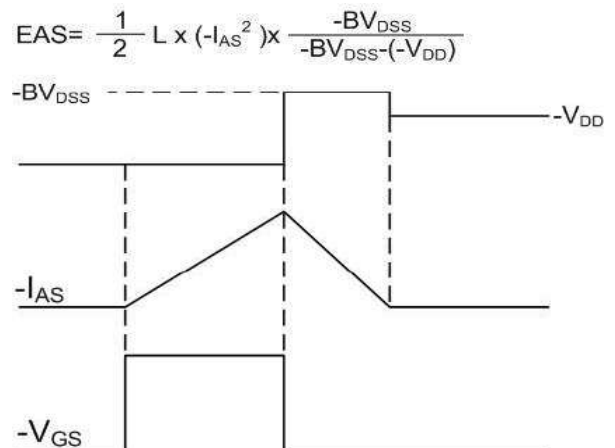

**Fig.11 Unclamped Inductive Waveform**

N-Ch and P-Ch Fast Switching MOSFET

$V_{DS}=40V$ ,  $I_D=23A$ ,  $R_{DS(ON)}=28m\Omega$

$V_{DS}=-40V$ ,  $I_D=-20A$ ,  $R_{DS(ON)}=40m\Omega$

## ➤ Recommmend IR Reflow Soldering Thermal Profile

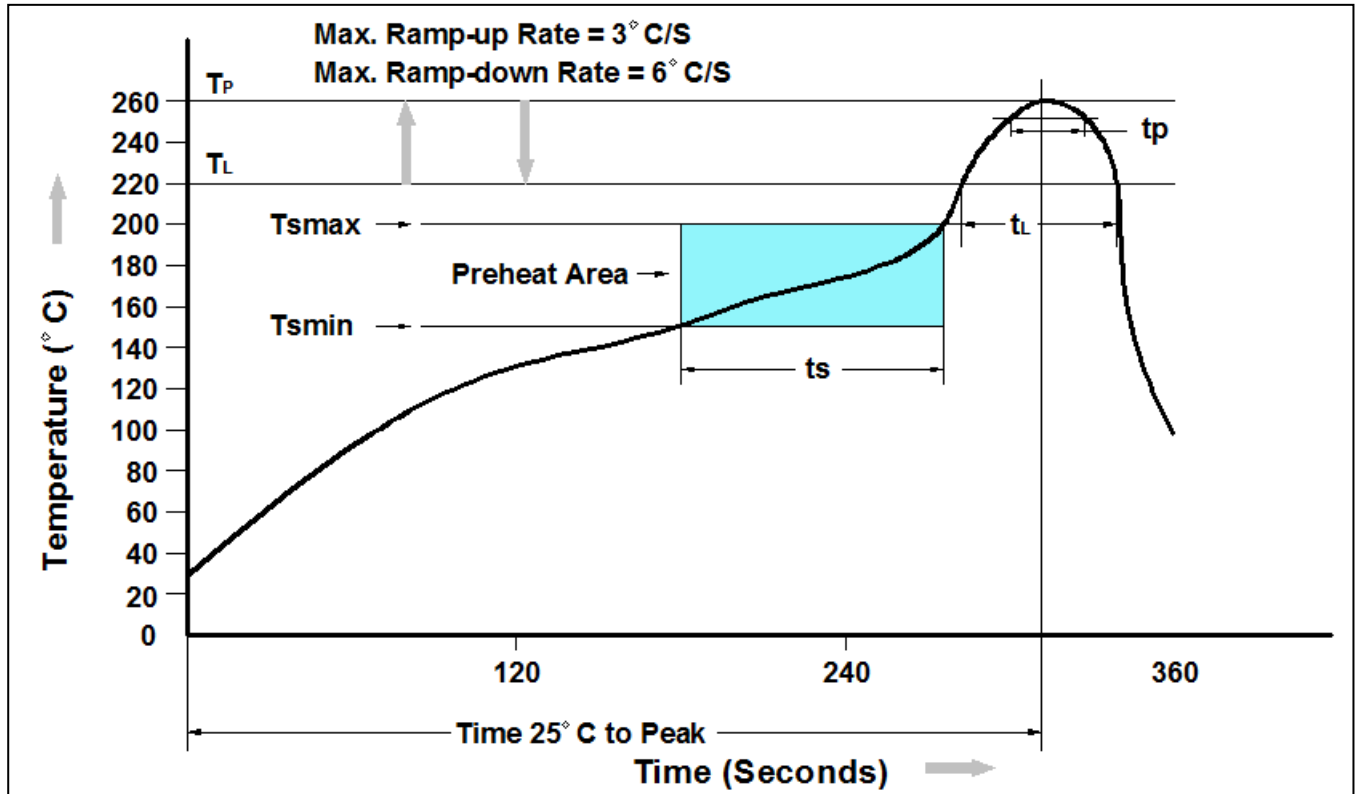

Profile Feature	Pb-Free Assembly Profile
Temperature Min. (T <sub>smin</sub> )	150°C
Temperature Max. (T <sub>smax</sub> )	200°C
Time (t <sub>s</sub> ) from (T <sub>smin</sub> to T <sub>smax</sub> )	60-120 seconds
Average Ramp-up Rate (t <sub>L</sub> to t <sub>P</sub> )	3°C/second max.
Liquidous Temperature (T <sub>L</sub> )	217°C
Time (t <sub>L</sub> ) Maintained Above (T <sub>L</sub> )	60 – 150 seconds
Peak Temperature	260°C +0°C / -5°C
Time (t <sub>P</sub> ) within 5°C of actual Peak Temperature	30 seconds
Ramp-down Rate (T <sub>P</sub> to T <sub>L</sub> )	6°C/second max
Time 25°C to Peak Temperature	8 minutes max.

## ➤ Ordering Information

Part Number	Description	Quantity
PAC49TX03X	TO-252-4L Reel	2500 pcs



N-Ch and P-Ch Fast Switching MOSFET

$V_{DS}=40V$ ,  $I_D=23A$ ,  $R_{DS(ON)}=28m\Omega$

$V_{DS}=-40V$ ,  $I_D=-20A$ ,  $R_{DS(ON)}=40m\Omega$

➤ Package Information ( TO-252-4L)

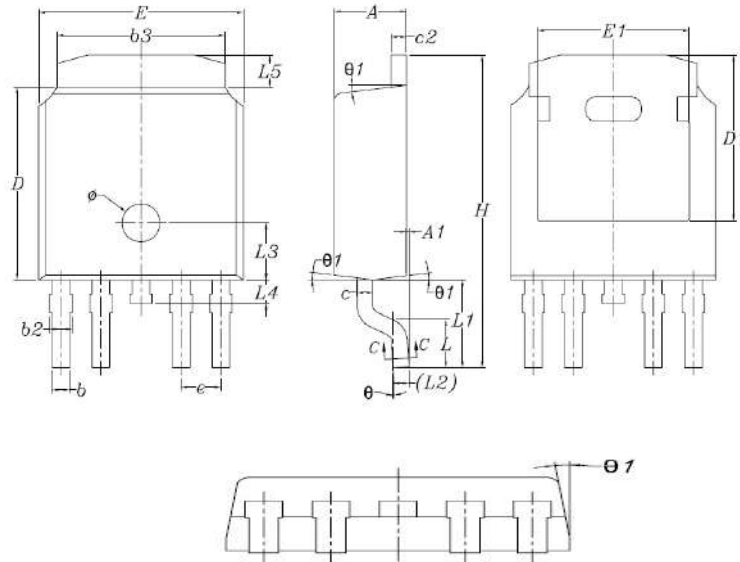

SYMBOLS	MILLIMETERS		INCHES	
	MIN	MAX	MIN	MAX
A	2.180	2.400	0.0860	0.0950
A1	-	0.127	-	0.0050
b	0.508	0.711	0.0200	0.0280
b2	0.610	0.790	0.0240	0.0310
b3	5.184	5.461	0.2041	0.2150
c	0.460	0.610	0.0181	0.024
c2	0.460	0.610	0.0181	0.024
D	6.000	6.223	0.2362	0.2450
D1	5.050	--	0.1988	--
E	6.350	6.731	0.2500	0.2650
E1	4.320	--	0.1700	-
e	1.170	1.370	0.0461	0.0539
H	9.500	10.300	0.3740	0.4055
L	1.380	1.780	0.0540	0.0700
L1	2.400	3.000	0.0945	0.1181
L2	0.508BSC		0.020BSC	
L3	1.600	2.000	0.0630	0.0787
L4	--	1.016	--	0.04
L5	0.889	1.270	0.035	0.05
θ	0°	10°	0°	10°
θ1	0°	15°	0°	15°
∅	1.050	1.350	0.0413	0.0531

**N-Ch and P-Ch Fast Switching MOSFET**

**$V_{DS}=40V$ ,  $I_D=23A$ ,  $R_{DS(ON)}=28m\Omega$**

**$V_{DS}=-40V$ ,  $I_D=-20A$ ,  $R_{DS(ON)}=40m\Omega$**

## DISCLAIMER

- The information in this document and any product described herein are subject to change without notice and should not be construed as a commitment by Paceleader, Paceleader reserve the right to make changes to the information in this document.
- Though Paceleader make effort to improve product quality and reliability, Product can malfunction and fail due to their inherent electrical sensitivity and vulnerability to physical stress, it is the responsibility of the customer, when utilizing Paceleader products, to comply with the standards of safety in making a safe design for entire system and to avoid situation in which a malfunction or failure., In developing a new designs, customer should ensure that the device which shown in this documents are used within specified operatingranges.
- The information contained herein is presented only as a guide for the applications of our products. No responsibility is assumed by Paceleader for any infringements of patents or other rights of the third parties which may result from its use.