

➤ General Description

This PAN40SY48Y N-Channel enhancement mode power field effect transistor is the high density trench technology and this advanced technology can provide excellent $R_{ds(On)}$ performance and efficiency for power switching and load switching application., this device also comply with the RoHS and Green Product requirement with full function reliability approved.

➤ Feature

- Super Low Gate Charge
- 100% EAS Guaranteed
- Green Device Available
- Excellent CdV/dt effect decline
- Advanced high cell density Trench technology

➤ DFN5X6A-EP1

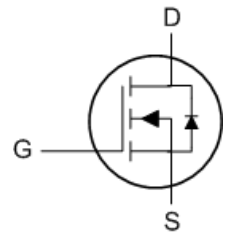
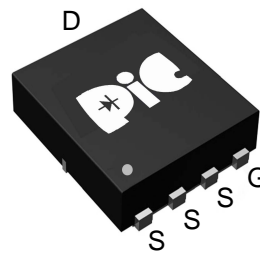

➤ Application

- DC/DC Primary Side Switch
- Industrial Synchronous
- Rectification Load Switch
- DC/DC Converters

➤ Absolute Maximum Ratings

| Parameter | Symbol | Rating | Units |
|---|-----------------------|------------|--------------|
| Drain-Source Voltage | V_{DS} | 40 | V |
| Gate-Source Voltage | V_{GS} | ± 20 | V |
| Continuous Drain Current, V_{GS} @ 10V _{1.6} | $I_D@T_C=25^\circ C$ | 100 | A |
| Continuous Drain Current, V_{GS} @ 10V _{1.6} | $I_D@T_C=100^\circ C$ | 82 | A |
| Pulsed Drain Current ² | I_{DM} | 400 | A |
| Single Pulse Avalanche Energy ³ | EAS | 400 | mJ |
| Avalanche Current | I_{AS} | 40 | A |
| Total Power Dissipation ⁴ | $P_D@T_C=25^\circ C$ | 125 | W |
| Storage Temperature Range | T_{STG} | -55 to 150 | $^\circ C$ |
| Operating Junction Temperature Range | T_J | -55 to 150 | $^\circ C$ |
| Thermal Resistance Junction-Ambient ¹ | $R_{\theta JA}$ | 50 | $^\circ C/W$ |
| Thermal Resistance Junction-Case ¹ | $R_{\theta JC}$ | 1 | $^\circ C/W$ |

➤ Electrical Characteristics ($T_J=25^\circ C$ Unless otherwise noted)

| Parameter | Symbol | Conditions | Min. | Typ. | Max. | Unit |
|---|--------------|--|------|------|-----------|------------|
| Drain-Source Breakdown Voltage | BV_{DSS} | $V_{GS}=0V$, $I_D=250\mu A$ | 40 | --- | --- | V |
| Static Drain-Source OnResistance ₂ | $R_{DS(ON)}$ | $V_{GS}=10V$, $I_D=20A$ | --- | 1.5 | 1.8 | m Ω |
| | | $V_{GS}=4.5V$, $I_D=20A$ | --- | 2.0 | 2.6 | |
| Gate Threshold Voltage | $V_{GS(th)}$ | $V_{GS}=V_{DS}$, $I_D=250\mu A$ | 1.2 | 1.6 | 2.2 | V |
| Drain-Source Leakage Current | I_{DSS} | $V_{DS}=32V$, $V_{GS}=0V$, $T_J=25^\circ C$ | --- | --- | 1 | uA |
| | | $V_{DS}=32V$, $V_{GS}=0V$, $T_J=55^\circ C$ | --- | --- | 5 | |
| Gate-Source Leakage Current | I_{GSS} | $V_{GS}=\pm 20V$, $V_{DS}=0V$ | --- | --- | ± 100 | nA |
| Forward Transconductance | g_{fs} | $V_{DS}=5V$, $I_D=20A$ | --- | 53 | --- | S |
| Gate Resistance | R_g | $V_{DS}=0V$, $V_{GS}=0V$, $f=1MHz$ | --- | 1.0 | --- | Ω |
| Total Gate Charge (4.5V) | Q_g | $V_{DS}=15V$, $V_{GS}=10V$, $I_D=20A$ | --- | 45 | --- | nC |
| Gate-Source Charge | Q_{gs} | | --- | 12 | --- | |
| Gate-Drain Charge | Q_{gd} | | --- | 18.5 | --- | |
| Turn-On Delay Time | $T_{d(on)}$ | $V_{DD}=15V$, $V_{GS}=10V$, $R_G=3.3\Omega$, $I_D=20A$ | --- | 18.5 | --- | ns |
| Rise Time | T_r | | --- | 9 | --- | |
| Turn-Off Delay Time | $T_{d(off)}$ | | --- | 58.5 | --- | |
| Fall Time | T_f | | --- | 32 | --- | |
| Input Capacitance | C_{iss} | $V_{DS}=20V$, $V_{GS}=0V$, $f=1MHz$ | --- | 3972 | --- | pF |
| Output Capacitance | C_{oss} | | --- | 1119 | --- | |
| Reverse Transfer Capacitance | C_{rss} | | --- | 82 | --- | |

➤ Diode Characteristics

| Parameter | Symbol | Conditions | Min. | Typ. | Max. | Unit |
|--|----------|---|------|------|------|------|
| Continuous Source Current _{1,6} | I_S | $V_G=V_D=0V$, Force Current | --- | --- | 100 | A |
| Diode Forward Voltage ₂ | V_{SD} | $V_{GS}=0V$, $I_S=1A$, $T_J=25^\circ C$ | --- | --- | 1.2 | V |

Note :

1. Pulse width limited by maximum junction temperature.
2. The data tested by pulsed, pulse width $\leq 300\mu s$, duty cycle $\leq 2\%$
3. The EAS data shows Max. rating. The test condition is $V_{DD}=25V$, $V_{GS}=10V$, $L=0.5mH$, $I_{AS}=40A$
4. Ensure that the channel temperature does not exceed $150^\circ C$.
5. The data is theoretically the same as I_D and I_{DM} , in real applications, should be limited by total power dissipation.
6. Package limitation current is 100A.

➤ Typical Characteristics

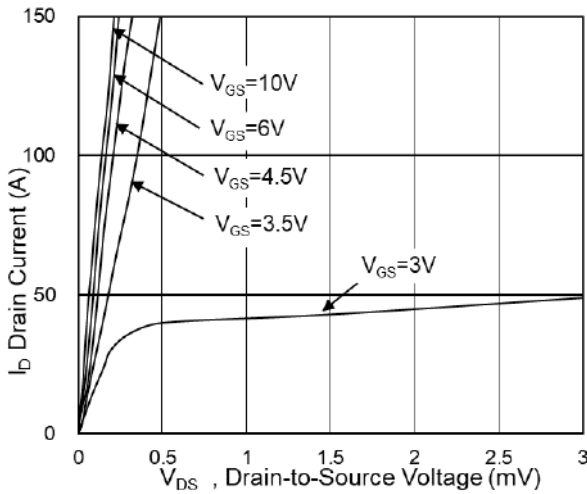

Fig.1 Typical Output Characteristics

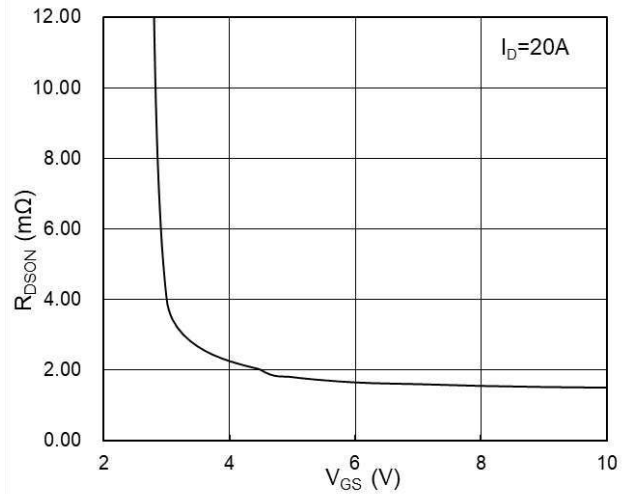

Fig.2 On-Resistance vs G-S Voltage

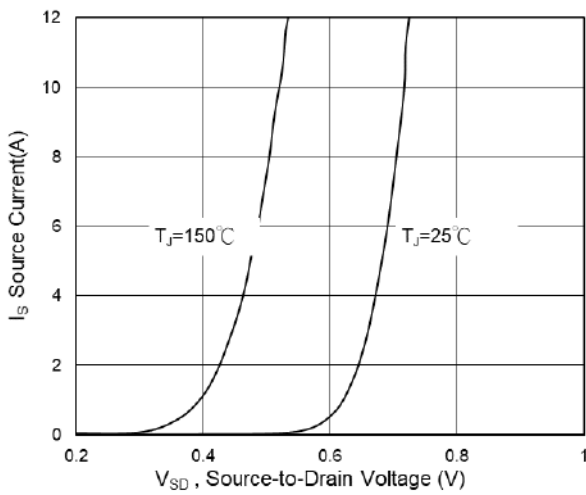

Fig.3 Source Drain Forward Characteristics

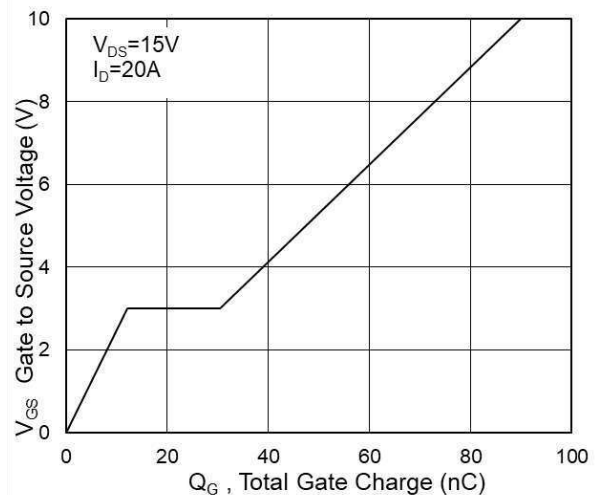

Fig.4 Gate-Charge Characteristics

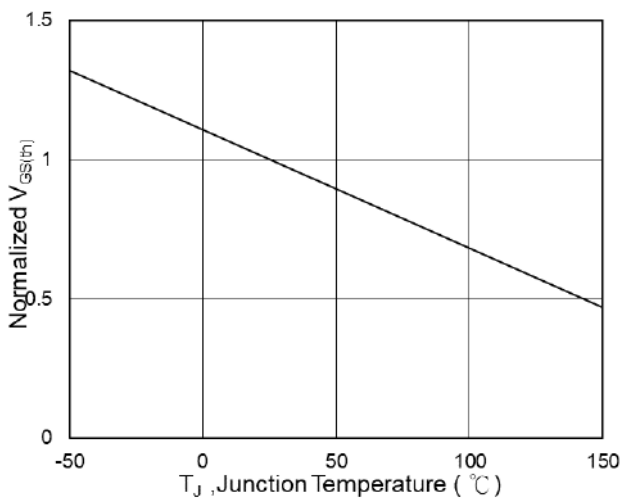

Fig.5 Normalized V_{GS(th)} vs T_J

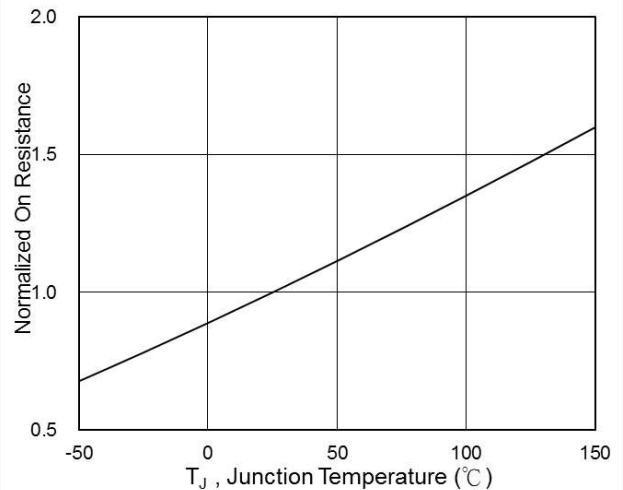

Fig.6 Normalized R_{DS(on)} vs T_J

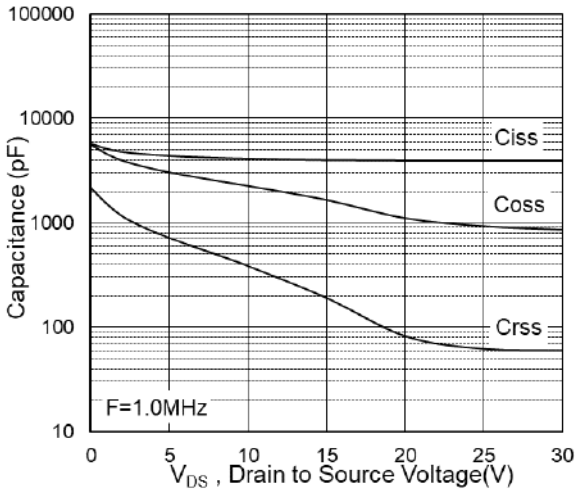

Fig.7 Capacitance

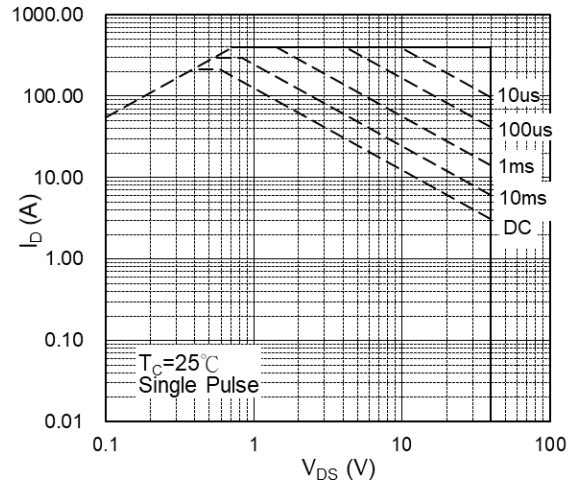

Fig.8 Safe Operating Area

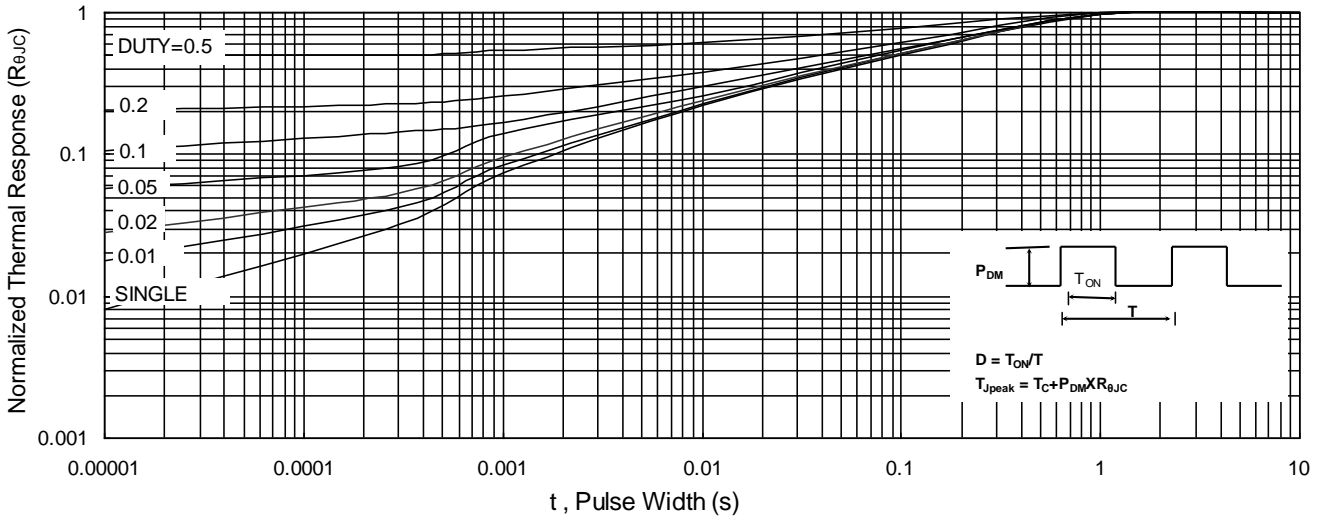

Fig.9 Normalized Maximum Transient Thermal Impedance

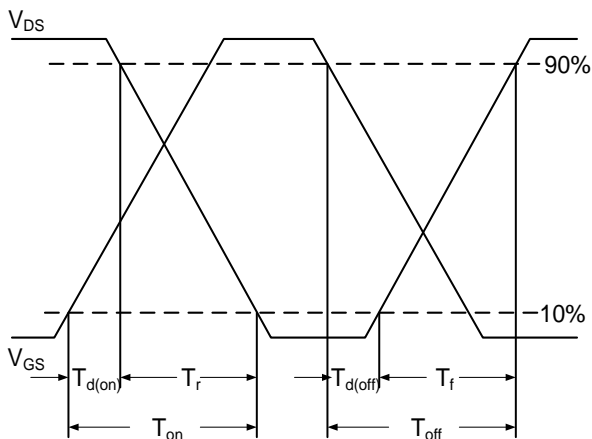

Fig.10 Switching Time Waveform

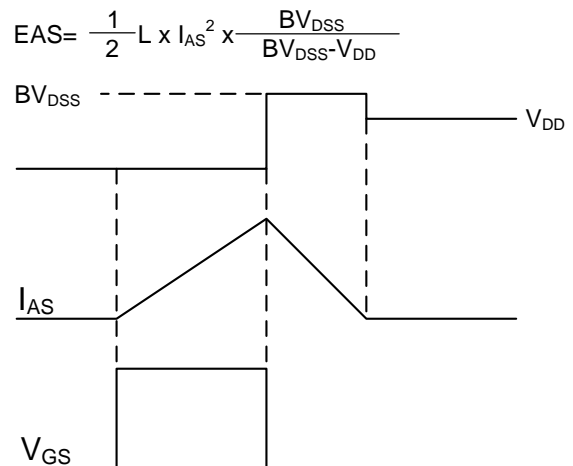

Fig.11 Unclamped Inductive Switching Waveform

➤ Recommand IR Reflow Soldering Thermal Profile



| Profile Feature | Pb-Free Assembly Profile |
|---|--------------------------|
| Temperature Min. (T _{smin}) | 150°C |
| Temperature Max. (T _{smax}) | 200°C |
| Time (t _s) from (T _{smin} to T _{smax}) | 60-120 seconds |
| Average Ramp-up Rate (t _L to t _P) | 3°C/second max. |
| Liquidous Temperature (T _L) | 217°C |
| Time (t _L) Maintained Above (T _L) | 60 – 150 seconds |
| Peak Temperature | 260°C +0°C / -5°C |
| Time (t _P) within 5°C of actual Peak Temperature | 30 seconds |
| Ramp-down Rate (T _P to T _L) | 6°C/second max |
| Time 25°C to Peak Temperature | 8 minutes max. |

➤ Ordering Information

| Part Number | Description | Quantity |
|-------------|------------------|----------|
| PAN40SY48Y | DFN5X6A-EP1 Reel | 3000 pcs |

➤ Package Information (DFN5X6A-EP1)

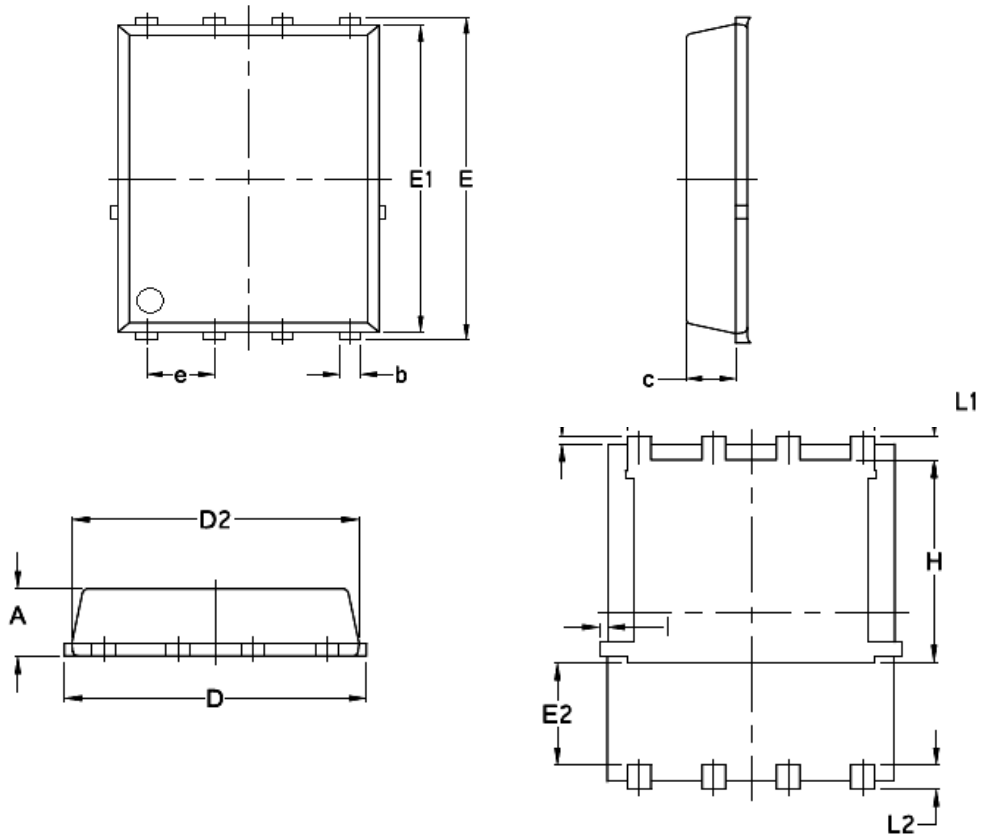

| SYMBOLS | MILLIMETERS | | INCHES | |
|---------|-------------|-------|----------|--------|
| | MIN | MAX | MIN | MAX |
| A | 1.03 | 1.17 | 0.0406 | 0.0461 |
| b | 0.34 | 0.48 | 0.0134 | 0.0189 |
| c | 0.824 | 0.970 | 0.0324 | 0.0382 |
| D | 4.80 | 5.40 | 0.1890 | 0.2126 |
| D1 | 4.11 | 4.31 | 0.1618 | 0.1697 |
| D2 | 4.80 | 5.00 | 0.1890 | 0.1969 |
| I | --- | 0.18 | --- | 0.0070 |
| E | 5.90 | 6.15 | 0.2323 | 0.2421 |
| E1 | 5.65 | 5.85 | 0.2224 | 0.2303 |
| E2 | 1.10 | --- | 0.0433 | --- |
| e | 1.27 BSC | | 0.05 BSC | |
| H | 3.30 | 3.78 | 0.1299 | 0.1488 |
| L | 0.05 | 0.25 | 0.0020 | 0.0098 |
| L1 | 0.38 | 0.61 | 0.0150 | 0.0240 |
| L2 | 0.38 | 0.71 | 0.0150 | 0.0279 |

DISCLAIMER

- The information in this document and any product described herein are subject to change without notice and should not be construed as a commitment by Paceleader, Paceleader reserve the right to make changes to the information in this document.
- Though Paceleader make effort to improve product quality and reliability, Product can malfunction and fail due to their inherent electrical sensitivity and vulnerability to physical stress, it is the responsibility of the customer, when utilizing Paceleader products, to comply with the standards of safety in making a safe design for entire system and to avoid situation in which a malfunction or failure., In developing a new designs, customer should ensure that the device which shown in this documents are used within specified operatingranges.
- The information contained herein is presented only as a guide for the applications of our products. No responsibility is assumed by Paceleader for any infringements of patents or other rights of the third parties which may result from its use.